

TEFAL

Visioclean



Bedienungsanleitung

User Instructions

Руководство для

пользователя

Návod na použitie

Návod k obsluze

Instrukcja obsługi

Használati útmutató

Uputstvo

Navodila za uporabo

Instrucțiuni de folosire

Uputstvo

Инструкции за

употреба

Visioclean

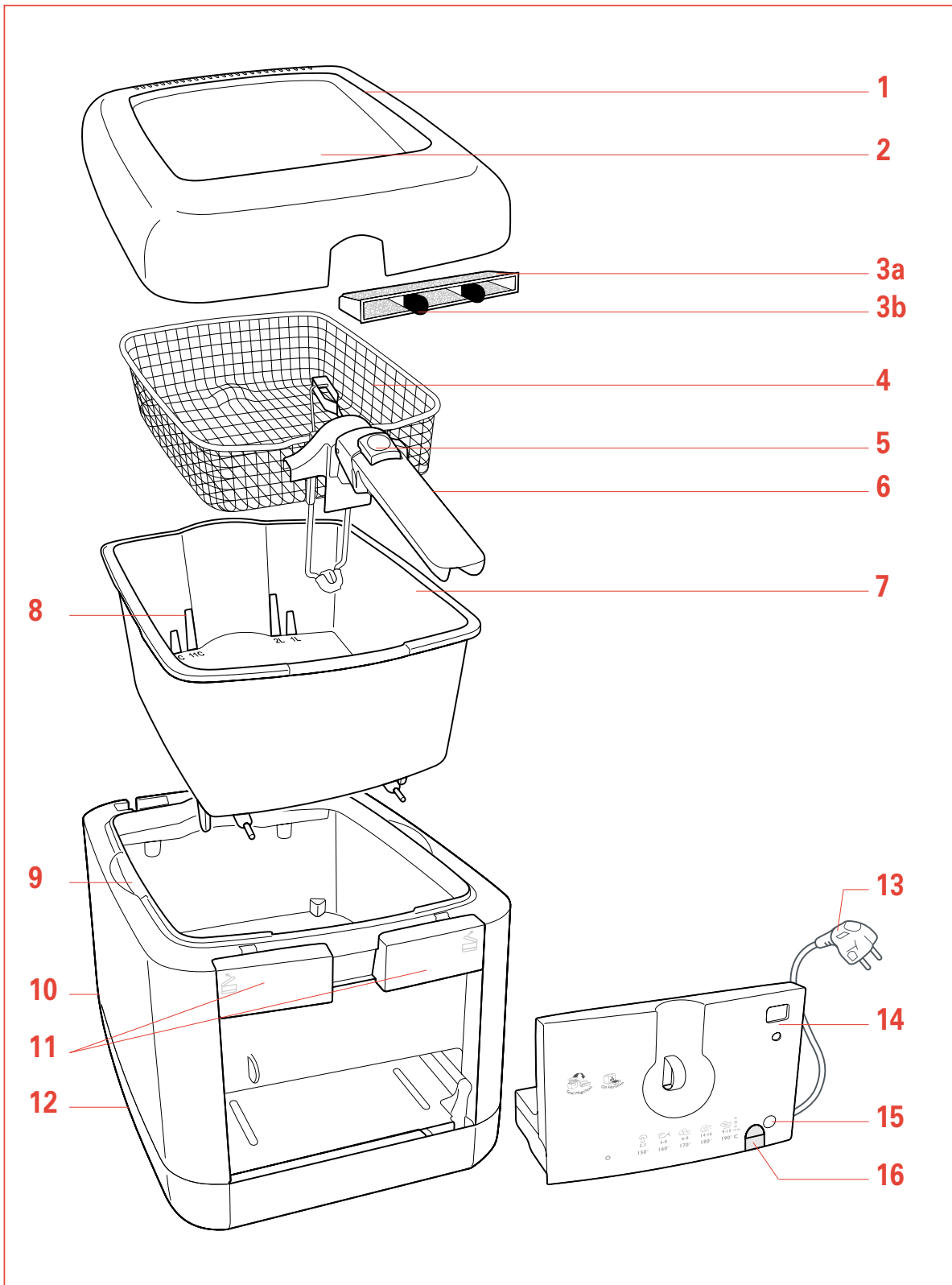

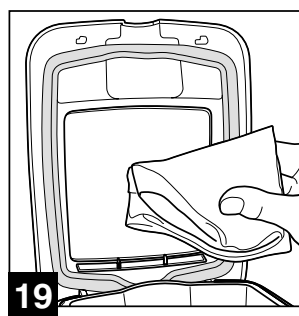
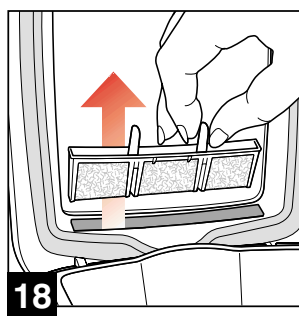
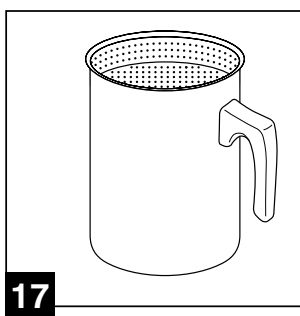
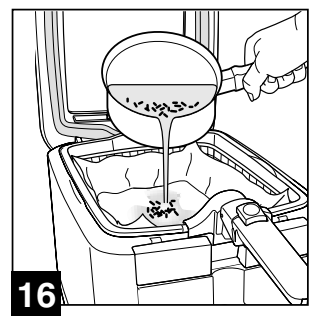
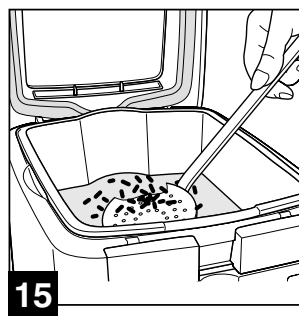
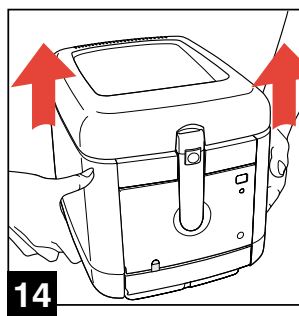
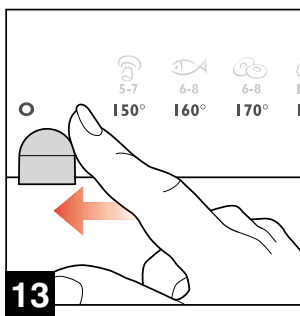
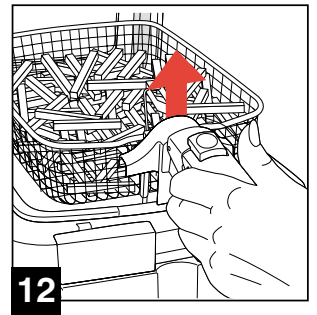
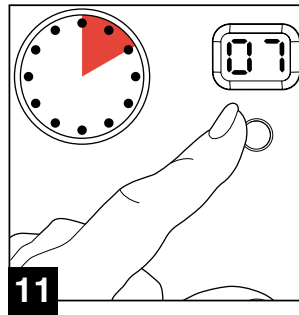
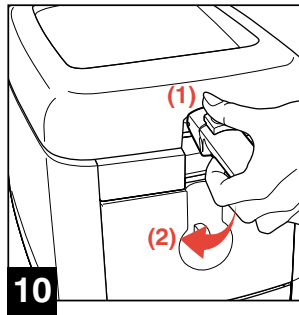
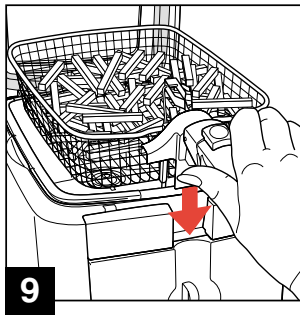
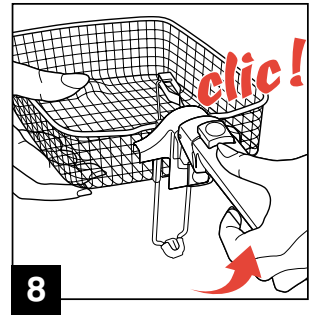
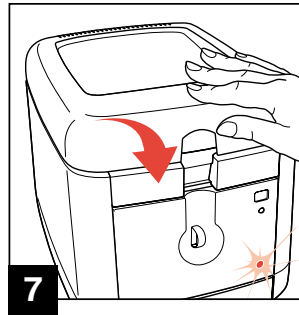
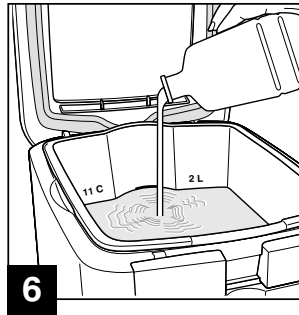
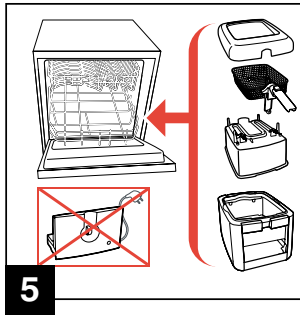
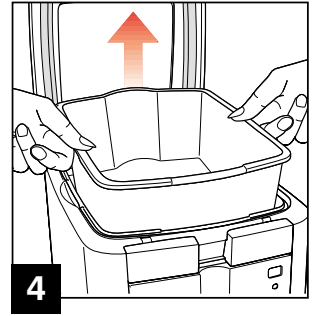
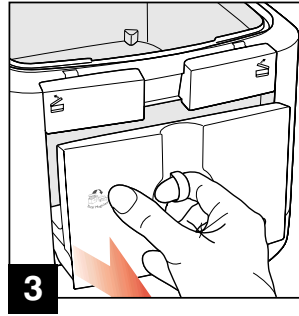
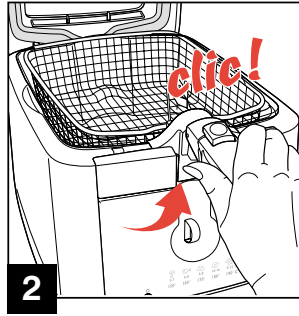
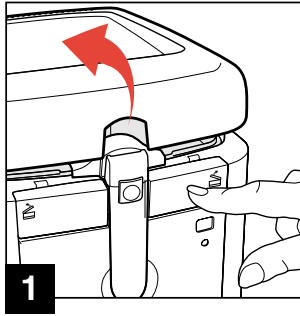

Protection of the environment

- Your appliance is intended to work for a long time. However, the day when you decide to replace your appliance, don't forget to think about how you can help to protect the environment.
- Dispose of it at your local waste disposal centre.



Read the directions for use and carefully follow instructions.

Safety instructions

- This appliance complies with safety rules and conditions in force together with Directives :
 - 89/336/EEC amended by 93/68/EEC.
 - 72/23/ CEE amended by 93/68/EEC.
- Check that the mains voltage corresponds correctly to that shown on the appliance (alternating current).
- Bearing in mind the diversity of standards in existence, if the appliance is used in a different country from that in which it was purchased, have it checked by an approved service centre.
- Use a stable flat work surface away from water splashes.
- Never leave the appliance running without supervision. Do not leave it within the reach of children.
- Do not leave the cord hanging down.
- Always plug the appliance into an earthed connection.
- Do not unplug the appliance by pulling on the cord.
- Do not use the appliance if :
 - the appliance or its cord is faulty,
 - the appliance has fallen and shows visible damage or signs of faulty operation. In this case, the appliance must be sent to an approved Service Centre.
- This appliance operates at high temperatures which can cause burns. Despite the good heat protection, do not touch the appliance's hot surfaces (filter, viewing window, etc.).
- If the power supply cord is damaged, it must be replaced by the manufacturer, its after-sales service or a similarly qualified person so as to avoid any danger.
- Always unplug the appliance :
 - as soon as you have finished using it,
 - if you want to move it,
 - each time you want to service or clean it.
- Never immerse the appliance in water !
- Do not move the appliance while it contains liquids or hot foods.
- Never try to take the bowl out while the fryer is in operation.
- This product is designed for domestic use only. Any inappropriate use, commercial use or failure to comply with the instructions, the manufacturer accepts no responsibility and the guarantee will not apply.

Description

- 1 Lid
- 2 Viewing window
- 3a Anti-odour carbon filter
- 3b Filter handling tabs
- 4 Basket
- 5 Basket release button
- 6 Handle for raising and lowering basket
- 7 Non-stick removable bowl
- 8 Bowl fill level marks (1L/2L)
- 9 Housing
- 10 Cord holder
- 11 Lid opening buttons
- 12 Carrying handles when cold
- 13 Plug with cord
- 14 Control panel
- 15 Temperature light
- 16 Thermostat

TOTAL MAGICLEAN / VARIABLE OIL LEVEL

Visioclean is a fryer with variable oil level allowing you to fry varied foods.

You can adapt the quantity of oil, 1 or 2 litres, to what you are cooking and cut down on the amount of fat.

Your Visioclean fryer also has the advantage that it can be completely taken apart to allow cleaning of all component parts.

- The lid, basket, bowl and housing can all go into the dishwasher.
- Your fryer's anti-odour filter can also be cleaned, without even detaching it from the lid and can also be put in the dishwasher.
- The front of the control panel can be wiped clean with a slightly dampened sponge.

Dismantling the fryer

Open the lid by pressing on one of the two buttons and pull it away from the fryer

- Fig. **1**

Lift the basket handle until you hear a "click" as it locks - Fig. **2**

Remove the basket.

After pulling the cord towards the front, remove the control panel - Fig. **3**

Take out the bowl from the housing.

Unscrew (1) the drain valve located on the bottom of the bowl - Fig. **4**

Preparation for use

Cleaning the fryer

Remove the protective film from the underside of the viewing window (depending on model).

Clean all parts (except the control panel) with a sponge and washing-up liquid or put them through the dishwasher - Fig. **5**
Dry them off.

 *For good visibility through the window, see chapter Cleaning.*

 *Never immerse the control panel and cord in water.*

 *Ensure that the anti-odour filter is dry before frying.*

Oil to use

Use an oil recommended for deep frying. For best results we recommend blended vegetable oil. For sunflower oil, groundnut oil, or soya oil, ensure the oil is changed after every 5 uses.

If you are using a solid vegetable fat:

Cut it into pieces and put it at the bottom of the bowl (without the basket).

Place the thermostat on the position 150°C for melting it then follow the manufacturer's recommendations for cooking.

Lard or dripping should not be used under any circumstances and may cause overflowing, smoking or risk of fire. For traditional UK style deep fried foods,

especially chips, we do not recommend using olive oil.

 **Do not mix different types of fat/oil.**

 **You have the possibility of frying your food with 1 litre of fat/oil or 2 litres of fat/oil depending on type of food (see cooking table).**

Filling the bowl

Fill the bowl (fitted with its automatic valve) with fat/oil.

Do not exceed the quantity corresponding to the marks for 2 L inside the removable bowl which correspond to 2 litres.

The marks for 1 L in the removable bowl correspond to a volume of 1 litre.

The bowl is also marked in UK cups 5 cps and 11 cps - Fig. **6**

Cooking method	Volume of oil	Solid fat
Deep frying	2 L	1785 g
Minimum deep-frying	1 L	890 g

 **Adjust the level of oil according to the amount of food being cooked ensuring that you stay within the Minimum and Maximum levels. Check each time before cooking and correct if necessary using the same type of fat/oil.**

Frying

Preheating

Check the fryer has oil/fat inside before switching on.

Close the lid - Fig. **7** Plug in.

Set the thermostat to the position corresponding to the food you are frying (see cooking tables p. 17).

The fryer is heating and the temperature light is on.

 **Never plug in the deep fryer without oil/fat inside.**

 **Never exceed the maximum quantity of food for safety.**

Removing the basket

Lift the basket handle until you hear the “click” as it locks - Fig. **8**

Fill the basket with food.

Reduce the quantities for frozen foods.

Put the basket in place on the edge of the bowl and leave the handle in the horizontal position - Fig. **9** Close the lid.

Frying (2 L)	Fresh chips	Frozen chips
Maximum capacity	1000 g	750 g
Quantity recommended for best results	550 g	400 g

 **Cut foods to the same size so that they cook evenly. Avoid using pieces that are too thick.**

 **Shake frozen foods in the basket to detach pieces of ice away from the deep fryer.**

Lowering the basket

When the oil has reached the right temperature, the light goes out.

Press on the basket release button (1).

Slowly fold back the handle fully into its slot (2), gently lowering the food into the hot oil - Fig. **10**

 **Do not push on the raising/lowering handle. Always press first on the handle's locking button.**

 **Do not leave the fryer unattended.**

Set the cooking time (depending on model)

Press on the timer button to set the time minute by minute - Fig. **11**

Release. The selected time (in minutes) is displayed and the countdown starts.

In case of mistake or to delete the selected time, hold the button down for 2 seconds.

To stop the ringing signal, press on the button.

 **Place the deep fryer:**

- on a steady level surface,
- where the lid can open fully and away from overhead cupboards,
- away from water splashes or heat sources,
- out of the reach of children.

 **Setting the timer is only possible when the temperature of the oil is reached.**

Cooking

Watch while cooking

During cooking, it is normal for the temperature light to go on and off.

 *It is normal for viewing condensation to obscure the window at the start of cooking.*

Taking food out

Lift the handle horizontally to raise the basket until you hear a “click” as it locks - Fig. **2**

Open the lid.

Take out the basket making sure that the rod is completely out of the bowl - Fig. **12**
Serve.

 *Do not touch:*
- the viewing window, the glass may be hot.
- the steam vented at the back of the fryer, will be hot.

 *The buzzer can be cancelled by pressing on the timer touchpad.*

For a second frying

Correct the level of oil if necessary, with the same type of oil.

Wait until the temperature light goes out before lowering the second batch of food.

 *To reduce the circulation of smells: don't leave the lid open for too long.*

Stopping the appliance

Once frying is completed, place the thermostat/control button on to position O - Fig. **13**

 *For crispier chips, open the lid immediately after draining.*

 *Season food with salt and pepper once out of the fryer to avoid getting into the oil/fat.*

Unplug the appliance.

Let the fryer cool down (1 to 2 hours).

Roll the cord behind the fryer.

To move the fryer, use the carrying handles - Fig. **14**

 *Never move the fryer with hot oil or fat inside.*

Maintenance

Storing the oil

Turn off the fryer and wait until the oil has completely cooled.

Use a skimming ladle to pick out the little pieces of food remaining in the fat - Fig. **15**
Leave the fat in the fryer or keep it in a separate container in a cool place (recommended if you do not use the fryer often).

 *Do not use metal tools.*

Filtering the oil

Use a filter paper (available from approved Service Centres).

Wait until the oil is lukewarm.

Carefully empty the oil into a saucepan.

Clean the inside of the bowl and dry.

Place a filter paper at the bottom of the basket.

Place the basket and filter paper in the fryer (handle in raised position).

Carefully pour the oil back into the bowl - Fig. **16**

Throw away the filter paper and clean the basket or use a filter pot with a maximum capacity of 2.4 L (available from approved Service Centres) - Fig. **17**

 *The oil must be filtered regularly. Crumbs falling away from foods tend to burn and cause the fat to deteriorate more quickly which in time will increase the risks of it catching fire.*

 *For the filter to work properly, change it after every 80 times you cook.*

Changing the oil

Do not pour used oil into the sink. Let it cool down and put it out with your household rubbish. If you add oil, make sure you use the same type.

 *Change the oil every 8 to 12 uses maximum. A "clean" oil keeps the flavour quality and lightness of foods and cuts down on smells.*

Changing the carbon filter

Open the fryer's lid.

Take out the filter using the holding tabs - Fig. **18**

Replace the new filter in the lid.

 *For the filter to work properly, change it after every 80 times you fry.*

 *If the filter falls into the hot fat, you have to change the fat and the filter.*

Cleaning

Visioclean is very easy to clean thanks to its exclusive system - Fig. **5**

TOTAL MAGICLEAN



You can put the following into the DISHWASHER:

- basket,
- lid (with FILTER),
- bowl,
- housing, after removing the control panel,

 *Take care the dishwasher rotating blades do not damage any of the fryer parts.*

Cleaning the window

For good visibility, put the lid through the dishwasher or clean it with a sponge dipped in washing-up liquid - Fig. **19**

Leave the window to dry in the surrounding air or wipe it with a clean cotton cloth. Replace the lid.

 *Clean the window each time the fryer has been used.*

 *Position the lid at 45° in the dishwasher, with the window upwards.*

Cleaning the removable bowl

The browning and scratches which may appear after long use are normal.

We guarantee that the non-stick coating complies with regulations concerning materials in contact with foodstuffs.

You can clean your bowl in the dishwasher. Be careful not to damage the coating with the racks in the dishwasher. Avoid distorting your bowl (particularly the outsides) through knocks or a fall.

 *To retain the non-stick qualities for as long as possible, do not use metal tools.*

 *If however your bowl becomes misshapen, obtain a replacement from your approved Service Centre.*

Cooking times

The cooking times and the quantities of fat are only a guide, they may vary depending on quantities and personal taste. For thicker foods (marked with an asterisk) and when cooking with 1 litre of oil, turn the food halfway through frying to ensure even cooking on both sides.

Foods recommended for frying in 1 litre of oil can be cooked in 2 litres of oil if preferred, using the same cooking temperature and time.

Cooks tip : when cooking battered foods or doughnuts, remove the wire basket to prevent food sticking to it. Take great care when handling the food and use tongs. Gradually place the food in the hot oil, submerging it an inch at a time to prevent it from sinking straight away.

Cooking time for fresh foods

Fresh foods	Quantity of oil	Temperature	Quantity	Time
Chips Maximum quantity	2 L	190°C	1000 g	14-16 min.
Chips Quantity recommended for best results	2 L	190°C	550 g	7-9 min.
Battered cod fillet	2 L	160°C	2 pieces	6-8 min.
Breaded camembert wedges	2 L	190°C	6 pieces	2-4 min.
Breaded chicken strips (chicken goujons)	2 L	180°C	8 pieces	5-6 min.
Breaded plaice fillet	1 L	160°C	1-2 pieces	5-7 min.
Chicken Kiev	2 L	180°C	2 pieces	12-14 min.
Fried chicken (leg portion)	2 L	180°C	2 pieces	15-20 min.
Fried whole mushrooms	2 L	150°C	200 g	4-6 min.
Fried onion rings	1 L	160°C	6-8 pieces	2-3 min.
Potato chicken croquettes	2 L	190°C	8-10 pieces	8-9 min.
Ring doughnuts	2 L	170°C	4 pieces	5-7 min.
Scotch eggs	2 L	170°C	2 pieces	6-8 min.
Apple fritters	2 L	170°C	4 pieces	4-6 min.

Cooking time for frozen foods

Frozen foods	Quantity of oil	Temperature	Quantity	Time
Chips Maximum quantity	2 L	190°C	750 g	11-13 min.
Chips Quantity recommended for best results	2 L	190°C	400 g	6-8 min.
American style thin cut chips	2 L	190°C	500 g	9-11 min.
Alphabites	1 L	190°C	16 pieces	3-4 min.
Battered cod fillets (large size)	2 L	190°C	2 pieces	11-13 min.
Breaded cod steaks	2 L	190°C	2-3 pieces	6-8 min.
Breaded fish nuggets	2 L	190°C	8 pieces	4-5 min.
Breaded mushrooms	2 L	190°C	16 pieces	4-5 min.
Breaded or battered onion rings	1 L	190°C	9-10 pieces	4-5 min.
Breaded whole plaice	1 L	190°C	1-2 pieces	7-9 min.
Breaded scampi	2 L	190°C	16 pieces	4-5 min.
Chicken nuggets	1 L	190°C	16 pieces	4-5 min.
Fish fingers	1 L	190°C	8 pieces	4-6 min.
Potato croquettes	2 L	190°C	8-10 pieces	5-6 min.

If your fryer is not working correctly

Problems and possible causes	Solutions
<p>The fryer is not working</p> <ul style="list-style-type: none"> -The appliance is not plugged in. -The thermostat button is in the off position (0). -The control panel is wrongly inserted. -The fryer was switched on without any oil or fat in the bowl. 	<ul style="list-style-type: none"> -Plug-in the appliance. -Place the thermostat button onto the temperature you want, check that the temperature light comes on. -Push the control panel firmly in. -Contact our helpline.
<p>Emits unpleasant smells</p> <ul style="list-style-type: none"> -The anti-odour filter is saturated or damaged. -The fat/oil has deteriorated. -The fat/oil is unsuitable. 	<ul style="list-style-type: none"> -Clean the filter, without the lid, or replace it (see p. 4). -Renew the frying oil (8 to 12 max.), more frequently depending on the oil. -Use a good quality blended vegetable oil.
<p>Steam is coming out around the lid</p> <ul style="list-style-type: none"> -The lid is not properly closed. -The seal is faulty. -The food has a high water content. 	<ul style="list-style-type: none"> -Make sure that the lid is properly locked/closed. -Contact our helpline. -A lot of steam is normal with maximum quantities of some foods e.g. chips.
<p>The frying oil is overflowing</p> <ul style="list-style-type: none"> -The maximum fill mark for the bowl has been exceeded. -The basket is too full or misshapen. -Mixture of different oils and fats. -Not changing the oil often enough. -Oil bubbling up too much. -Using the wrong oil. 	<ul style="list-style-type: none"> -Check the oil level (maxi) and take out any surplus. -Check that the basket is not too full. -Change your basket. -Empty and clean the bowl. Refill the bowl with only one type of fat/oil. Change oil every 8 to 12 uses, more frequently depending on the oil. -Shake off loose ice and dry foods well. -Lower the basket very gently. -Only use vegetable oil/fats.
<p>Foods are not browning and stay soft</p> <ul style="list-style-type: none"> -They are too thick and contain too much water. -Too much food being cooked at the same time and the cooking oil is not at the right temperature. -The temperature of the frying oil may not be high enough: the thermostat is set incorrectly. 	<ul style="list-style-type: none"> -Experiment by lengthening the cooking time or cut foods thinner. -Fry foods in small quantities (especially when frozen). -Set the thermostat to the recommended temperature.
<p>The timer no longer works</p> <ul style="list-style-type: none"> -The battery is spent. 	<ul style="list-style-type: none"> -Unlock the battery shield on the back of the control panel. -Put a new battery in (ref.: VINNIC L1131 DI). -Dispose of the battery in a specialised collection centre.

Difficult to see through the viewing window.

-Too much cooking without cleaning the window.

-Clean with a non abrasive cloth.

-Put the lid through the dishwasher or clean it with a sponge to which you have added some washing-up liquid.

-Leave the window to dry in the surrounding air or wipe it with a clean cotton dishcloth and lemon juice.

HELPLINE

For any problems or queries please telephone:

0845 602 1454 (UK - calls charged at local rate)

(01) 4751947 (Ireland) or consult our website: www.tefal.co.uk

 *Any repairs must be carried out only by an approved Service Centre using original spare parts.*

TEFAL