

Important precautions

- **Take the time to read all the instructions and refer to the "Instructions for use".**
- As with any cooking appliance, supervise cooking closely if using the X'press Cooker with children nearby.
- Do not put your X'press Cooker into a hot oven.
- When the X'press Cooker is under pressure, take great care when moving it. Do not touch the hot surfaces. Use the handles and knobs, and wear gloves if necessary.
- Do not use your X'press Cooker for any use other than that for which it is designed.
- Your X'press Cooker cooks under pressure. Burns could result from boiling over if not used properly. Make sure that the X'press Cooker is properly closed before bringing it up to pressure.
- Never force the X'press Cooker open. Make sure that the inside pressure has returned to normal.
- Never use your X'press Cooker without liquid: this could cause serious damage.
- Use compatible heat sources.
- Do not fill your X'press Cooker more than 2/3 full. For food that expands considerably during cooking, such as rice, dehydrated vegetables or compotes, do not fill the X'press Cooker more than half full.
- After cooking meat which has an outer layer of skin (such as ox tongue), which could swell due to the effects of pressure, do not pierce the skin after cooking if it appears swollen: you could get burnt. Pierce it before cooking.
- When cooking food with a thick texture (chick peas, rhubarb etc.) the X'press Cooker should be shaken slightly before opening to ensure that the food does not spurt out.
- Always check that valves are clear before use.
- Do not use the X'press Cooker to fry under pressure using oil.
- Leave the safety systems alone, except for cleaning and maintenance in accordance with instructions.
- Use only the appropriate TEFAL spare parts for your model.

Keep these instructions



Diagram

1

Features

2

Opening • Closing

3

Filling

4

**Use of
the pressure regulator valve**

5

Using for the first time

6

Before cooking

7

During cooking

8

End of cooking

9

Cleaning and maintenance

10

**TEFAL is safe
TEFAL answers your questions**

11

1

Diagram

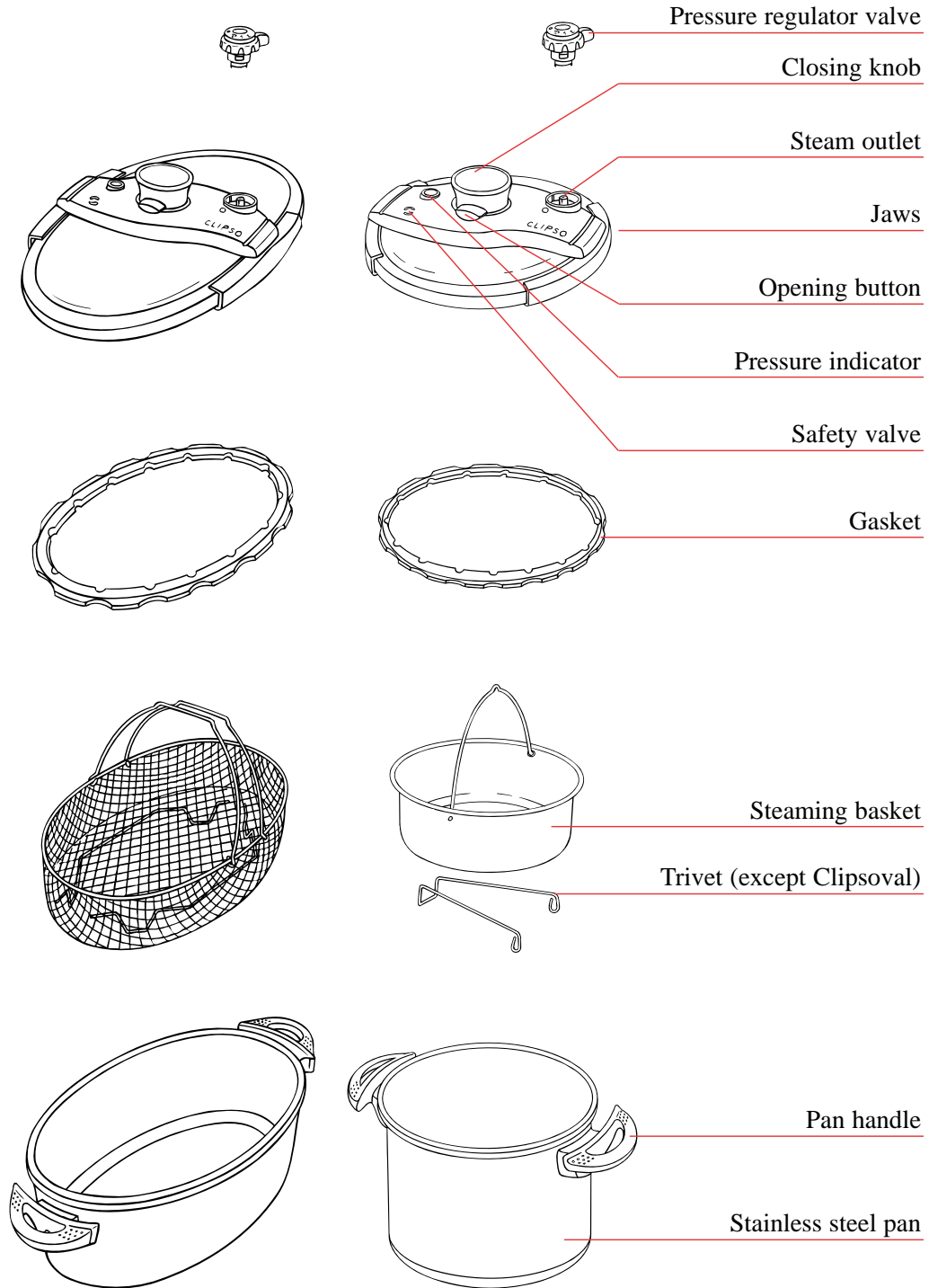

2

Features



Bottom diameters

Capacity	Base Ø	Models
3 L	18 cm	4101
4,5	18 cm	4102
6 L	18 cm	4103
7,5 L	18 cm	4104
8 L	20 cm	4105
10 L	20 cm	4106
8 L Clipsoval	26x18 cm	4128

Compatible heat sources

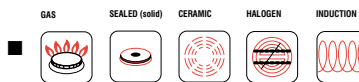

- The CLIPSO X'press Cooker is suitable for all hob types including induction.
- When using an electric hob, use a hob with the same diameter as the bottom of the X'press Cooker, or slightly smaller.
- When using a ceramic hob, make sure the bottom of the Cooker is perfectly clean.
- When using gas, the flame should not exceed the diameter of the pan.

TEFAL accessories

- The accessories available for the CLIPSO X'press Cooker are:

Pressure regulator valve		ref. 980026
Tightening knob		ref. 980025
Steaming basket	Stainless steel pan 4,5 L	ref. 793174
	Stainless steel pan 6 L/7,5 L	ref. 793175
	Stainless steel pan 8 L/10 L	ref. 980078
Gasket	Clipsoval stainless steel pan	ref. 980079
	3 L/4,5 L/6 L/7,5 L	ref. 793145
	8 L/10 L	ref. 794599
	Clipsoval	ref. 980029

- Please contact your TEFAL After Sales Service if you need to change other parts or for repairs.
- Only use genuine TEFAL parts to match your model.

Opening

3

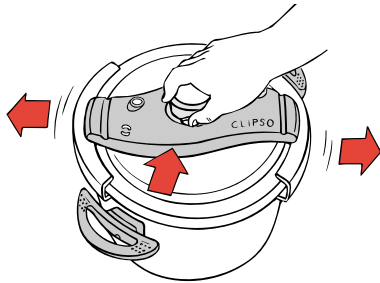

- Press the lid opening button, the jaws open.

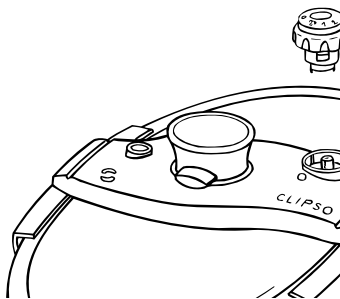

- Lift the lid.

Closing

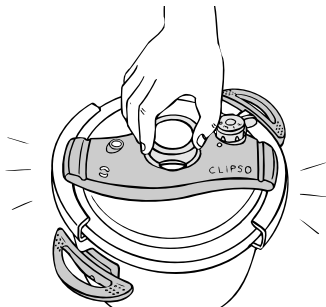

- Place the lid on the pan making sure that it fits correctly onto the pan body.

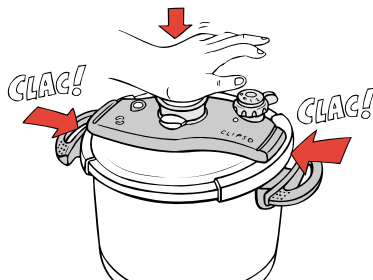

- Press the closing button on the lid.

If you cannot close the lid

- Check that the jaws are completely open before putting the lid on the pan.

4

Minimum filling

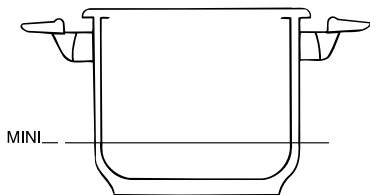

- Never use your X'press Cooker without at least 25 cl (2 glasses) of water.

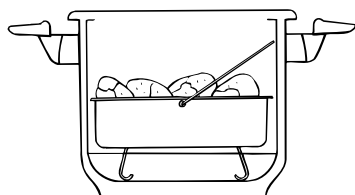

Steaming

- The minimum amount of water is 75 cl.
- Place the steaming basket on the trivet.
- *With Clipsoval, the trivet is an integral part of the basket.*

4

Maximum filling

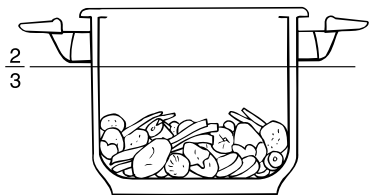

- Never fill your X'press Cooker to more than 2/3 of the pan height.

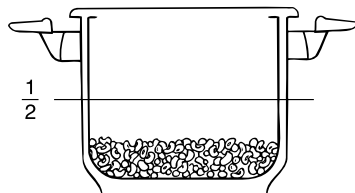

For certain foods

- For foods that dilate during cooking, such as rice, dried vegetables or stewed fruit, do not fill the pan to more than half of its height.

If the X'press Cooker has heated without any liquid inside:

- Have your X'press Cooker checked by an Approved TEFAL After-Sales Centre.

Using the pressure regulator valve

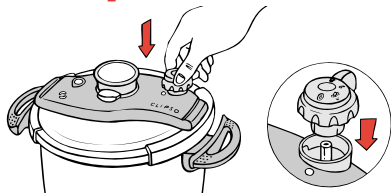

Positioning the pressure regulator valve

- Position the pressure regulator valve by placing the **0** opposite the white dot on the lid.
- Press the pressure regulator valve down on the steam outlet until you hear a click.
- Turn to the required position.

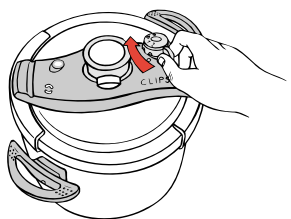

Cooking delicate foods and preserving vitamins

- Place the pressure regulator valve on **1**.

Cooking meat and defrosting

- Place the pressure regulator valve on **2**.

5

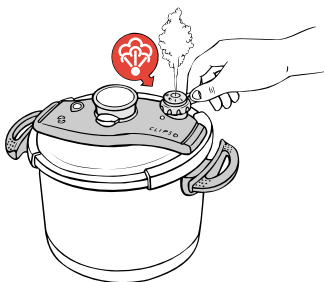

Releasing steam

- Place the pressure regulator valve on .

 *The steam is very hot when it escapes from the pressure regulator valve.*

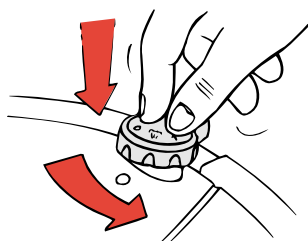

Removing the pressure regulator valve

- Press on the central part and turn the pressure regulator valve to position **0**.
- Remove the pressure regulator valve.

The steam escapes via the pressure regulator valve with a sharp hissing noise:

- Turn off the heat.
- Leave the Cooker to cool.
- After opening the Cooker, check that the steam outlet is not blocked up by food.

6

Using for the first time

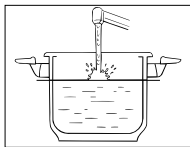

- Fill with water to 2/3 of the pan height.

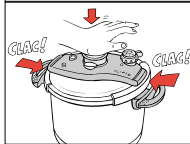

- Close the X'press Cooker.

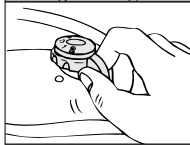

- Place the pressure regulator valve on **2**.

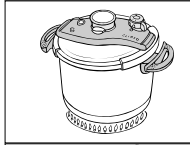

- Put the X'press Cooker on the hob and set to maximum heat.

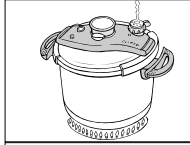

- When steam begins to escape from the valve, turn the heat down and wait for 15 minutes.

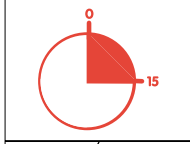

- After 15 minutes turn off the heat.

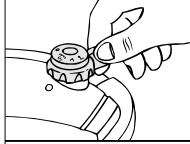

- Place the valve on  .

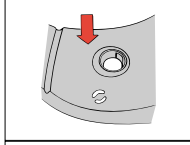

- When no more steam comes out of the pressure regulator valve and the pressure indicator is in its low position, open the X'press Cooker.

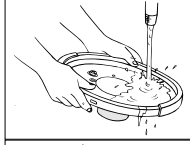

- Rinse the X'press Cooker with cold water and dry.



- N.B.: The appearance of stains on the inside bottom of the pan does not affect the quality of the metal. These are marks left by hard water. Use a little diluted vinegar and a scouring pad to make them disappear.

6

Before cooking

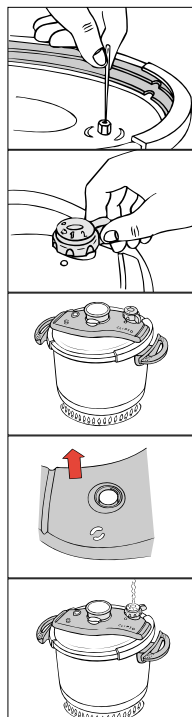

- Before each use, check that the steam outlet is not blocked up.
- Fit the pressure regulator valve.
- Position the pressure regulator valve as indicated in your recipe (position **1** ou **2**).
- Place the X'press Cooker on the hob turned up to maximum.

 ***As soon as the pressure indicator rises, you will be unable to open the X'press Cooker.***

- Cooking begins when the pressure regulator valve allows steady release of steam, making a regular hissing noise.

7

If the pressure has not risen and nothing escapes from the valve during cooking:

- This is normal for the first few minutes.
- If the phenomenon persists check that:
 - The heat is turned up enough, if not turn it up.
 - There is enough liquid in the pan.
 - The pressure regulator valve is on 1 or 2
 - The X'press Cooker is properly closed.
 - The gasket or the side of the pan are not damaged.

If the pressure indicator has risen and nothing escapes from the valve during cooking:

- Put your X'press Cooker under the cold water tap to decompress.
- Clean the pressure regulator valve and the steam outlet.

During cooking

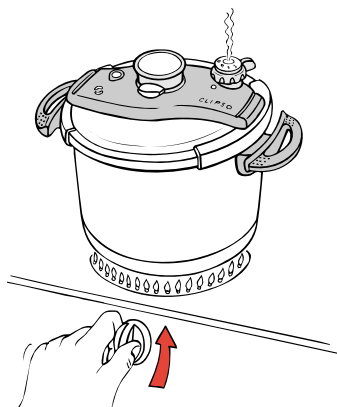

- Turn the heat down as soon as the pressure regulator valve allows steam to escape at a constant rate, making a regular hissing noise.

 *As with any cooking utensil, close supervision is required if you are using it within the proximity of children.*

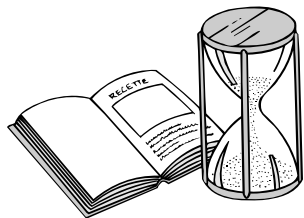

- Calculate the cooking time given in the recipe.
- Turn the heat off as soon as the cooking time is reached.

If steam escapes from under the lid, check:

- That the lid is properly closed.
- The position of the lid gasket.
- The good condition of the gasket and change it if necessary.
- The cleanliness of the lid, safety valve and pressure regulator valve.
- The good condition of the edge of the pan.

If one of the safety systems (safety valve or gasket) is activated:

- Turn off the heat
- Allow the X'press Cooker to cool down.
- Check the pressure regulator valve and the steam outlet.

8

End of cooking

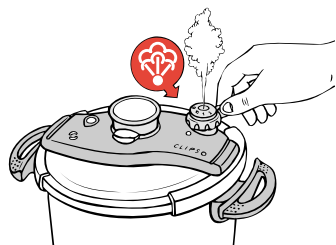

To release the steam

■ Once the heat has been turned off, you have two possibilities:

□ **Slow decompression:** turn the pressure regulator valve to  position.

 **Take care of hot steam.**

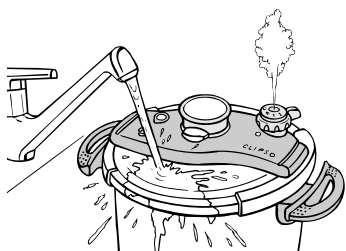

□ **Quick decompression:** put the X'press Cooker under the cold water tap.

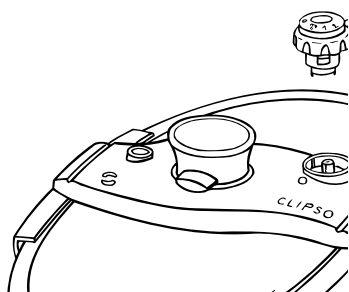

■ When the pressure indicator comes down, your Cooker is no longer under pressure.

■ You can open your X'press Cooker.

 **Use the handles to move the X'press Cooker.**

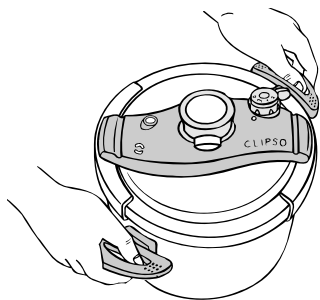

If you cannot open the lid

□ Check that the pressure indicator is in low position.

□ If not, decompress and cool the X'press Cooker under a jet of cold water if necessary.

If the food is not cooked or if it is burnt, check:

■ The cooking time

■ Whether the source of heat is turned up enough.

■ The proper positioning of the pressure regulator valve.

■ The quantity of liquid.

Cleaning and maintenance



⚠ *Do not leave food in your X'press Cooker.
Never use bleach or any chlorinated products.*

- Wash the X'press Cooker after each use with warm water and a little washing-up liquid.



Cleaning the pan

- Use a scouring pad to clean the inside of the pan.
- Use a non-abrasive sponge for the outside of the pan.
- The pan can be cleaned in a dish-washer.
- If the pan has become black, clean using a special stainless steel cleaner obtainable from an Approved TEFAL After-Sales Centre.

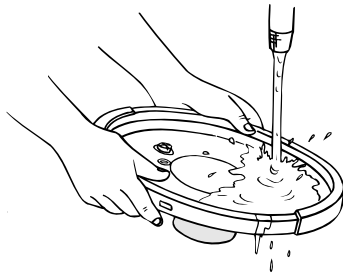

Cleaning the lid

- Wash the lid with water using a sponge and washing-up liquid.

⚠ *Do not put the lid in the dish washer.
Do not leave the lid to soak in water.*

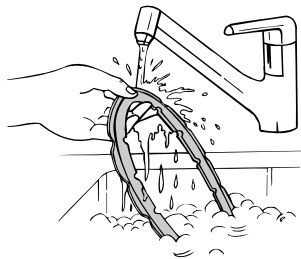

Cleaning the lid gasket

- Clean the gasket and its housing after each use.

⚠ *Change the gasket every year*

Cleaning and maintenance

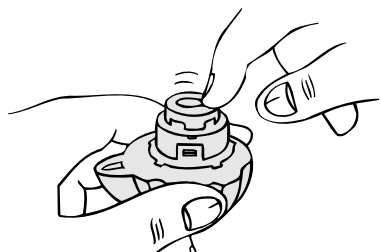

Cleaning the pressure regulator valve

- Clean the pressure regulator valve with water.
- Ensure that the inside slides freely.

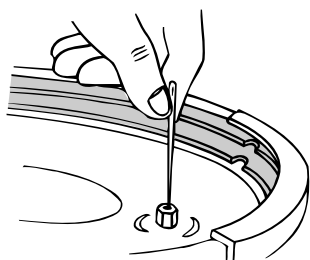

Cleaning the steam outlet

- Hold up to the light to ensure that the steam outlet is round and not blocked up. Clean with a needle.

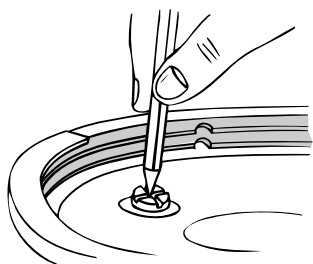

Cleaning the safety valve

- Clean the base of the safety valve inside the lid.
- Check that it is working properly by pressing slightly on the valve which must move freely.

 **Have your X'press Cooker checked by an Approved TEFAL After-Sales Centre after 10 years use.**

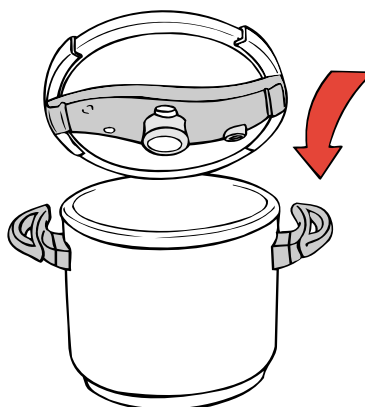

Storage of your X'press Cooker

- Turn the lid upside down on the pan.

If food has burnt in the X'press Cooker:

- Allow the pan to soak for a while before washing.
- Never use bleach or chlorinated products.

TEFAL is safe

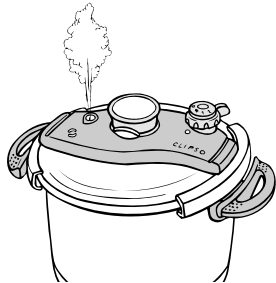

Your X'press Cooker has several systems to ensure perfectly safe cooking.

Safe closing system

- The jaws must be in contact with the edge of the lid.
- If not, steam will escape from underneath the pressure indicator and steam will not build up.

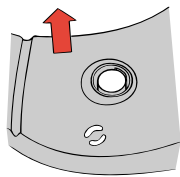

Safe opening system

- If the X'press Cooker is under pressure, the opening button cannot be operated because the mechanism is locked by the pressure indicator.

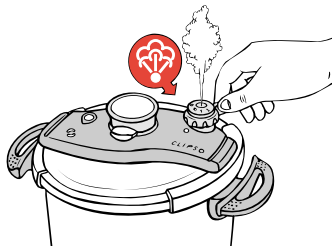

- In this case, do not try to force the opening, but bring the valve to  and wait until complete evacuation of the steam.

- Check the pressure indicator position. It must be in low position to be opened.



Safety with excess pressure

- During cooking, should the steam outlet become blocked, the excess pressure safety systems will come into operation:

- **First stage:** the safety valve releases the pressure.
- **Second stage:** the gasket allows the pressure to be released between the lid and the pan.

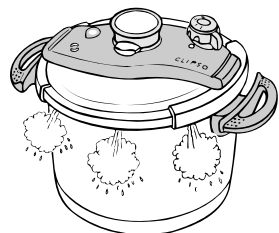

If one of the safety systems comes into operation:

- Turn the heat off.
- Allow the X'press Cooker to cool.
- Open.
- Check and clean the pressure regulator valve, steam outlet, safety valve and gasket.

TEFAL

answers your questions

If you cannot close the lid

- Check that the jaws are completely open before putting the lid on the pan.

If the X'press Cooker has heated without any liquid inside:

- Have your X'press Cooker checked by an Approved TEFAL After-Sales Centre.

The steam escapes via the pressure regulator valve with a sharp hissing noise:

- Turn off the heat.
- Leave the Cooker to cool.
- After opening the Cooker, check that the steam outlet is not blocked up by food.

If the pressure has not risen and nothing escapes from the valve during cooking:

- This is normal for the first few minutes.
- If the phenomenon persists check that:
 - The heat is turned up enough, if not turn it up.
 - There is enough liquid in the pan.
 - The pressure regulator valve is on 1 or 2
 - The X'press Cooker is properly closed.
 - The gasket or the side of the pan are not damaged.

If the pressure indicator has risen and nothing escapes from the valve during cooking:

- Put your X'press Cooker under the cold water tap to decompress.
- Clean the pressure regulator valve and the steam outlet.

If steam escapes from under the lid, check:

- That the lid is properly closed.
- The position of the lid gasket.
- The good condition of the gasket and change it if necessary.
- The cleanliness of the lid, safety valve and pressure regulator valve.
- The good condition of the edge of the pan.

If one of the safety systems (safety valve or gasket) is activated:

- Turn off the heat
- Allow the X'press Cooker to cool down.
- Check the pressure regulator valve and the steam outlet.

If you cannot open the lid

- Check that the pressure indicator is in low position.
- If not, decompress and cool the X'press Cooker under a jet of cold water if necessary.

If the food is not cooked or if it is burnt, check:

- The cooking time
- Whether the source of heat is turned up enough.
- The proper positioning of the pressure regulator valve.
- The quantity of liquid.

If food has burnt in the X'press Cooker:

- Allow the pan to soak for a while before washing.
- Never use bleach or chlorinated products.

If one of the safety systems comes into operation:

- Turn the heat off.
- Allow the X'press Cooker to cool.
- Open.
- Check and clean the pressure regulator valve, steam outlet, safety valve and gasket.

Guarantee



■ Your new TEFAL X'press Cooker is guaranteed for 10 years from date of purchase against any faulty materials or workmanship related to its metallic structure or non-stick coating (blistering or peeling) during normal use. Please follow carefully the instructions for use.

■ This guarantee does not cover :
- normal wear and tear, damage due to accident, misuse or commercial use,
- faulty packaging or mishandling in transit.
- parts subject to replacement : gasket, handles, pressure regulator valve, basket.



■ Guarantee claims and repairs are covered only by TEFAL authorised After Sales Service Centres.

■ Please refer to the enclosed International Guarantee card for your nearest Centre.

TEFAL



Juin 1998
Réf.: 4049160

Conception et réalisation: ADHOC STUDIO

