

KFC-HQ570

SERVICE MANUAL

KENWOOD





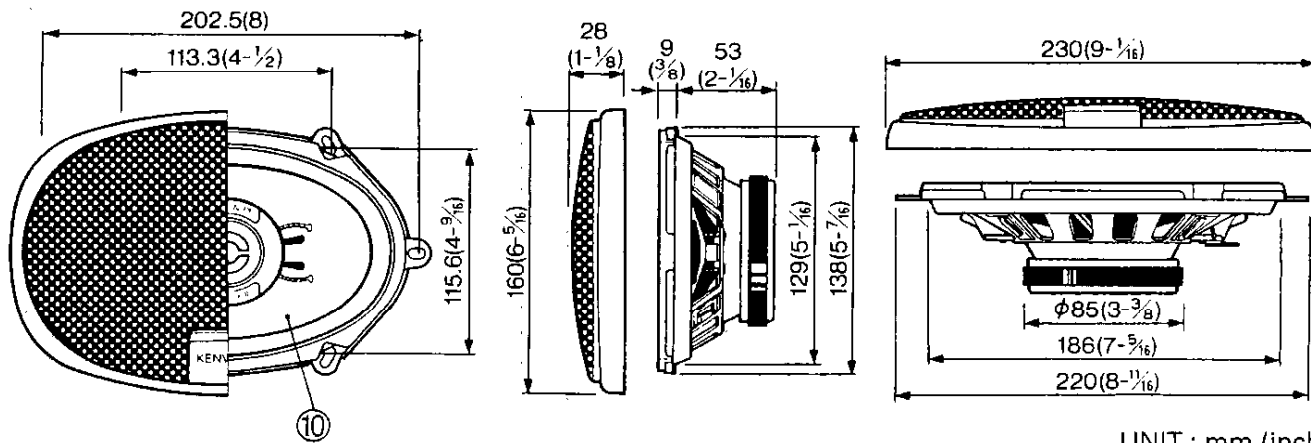

© 1993-3 PRINTED IN JAPAN
B51-6575-00(O) 432

EXTERNAL VIEW



UNIT : mm (inch)

PARTS INCLUDED

- | | |
|---|---|
| ① $\phi 4 \times 60$
($\phi 3/16 \times 2-3/8$) X 8 | ⑥  X 2 |
| ② $\phi 4 \times 25$
($\phi 3/16 \times 1$) X 8 | ⑦  X 2 |
| ③ $\phi 4 \times 10$
($\phi 3/16 \times 3/8$) X 8 | ⑧  X 1 |
| ④  X 8 | ⑨  X 2 |
| ⑤  X 8 | |

SPECIFICATIONS

- | | |
|------------------------|--|
| Speakers | |
| Woofer | 138 X 195mm (5 X 7 in) Injection P.P.Cone Type |
| Tweeter | 240g (8.3oz) Magnet |
| Tweeter | 25mm (1 in) Balanced Dome Type |
| Peak Power | 120 Watts |
| Frequency Response | 40Hz ~ 30,000Hz |
| Sensitivity | 91dB/W at 1m |
| Impedance | 4 Ohms |
| Net Weight With Grille | 1,820g (4.0lb) / Pair |

We follow a policy of advancements in development. For this reason specifications may be changed without notice.

PARTS LIST

* New parts

Parts without **Parts No.** are not supplied.

Ref. No.	Address	New	Parts No.	Description	Desti- nation	Re- mark
参照番号	位置	新	部品番号	部品名 / 規格	仕向	備考
K F C - H Q 5 7 0						
① ~ ④		*	N99-1244-08	SCREW SET		
⑤		*	J31-0332-08	COLLAR		
⑥		*	B06-0774-08	GRILLE		
⑦		*	F09-1065-08	PROTECTOR		
⑧		*	J69-0103-08	BUTYL RUBER		
⑨		*	E30-5145-08	CORD SET		
⑩		*	T15-0232-08	SPEAKER		