

+GF+ SIGNET 8750-2 pH/ORP Transmitter



3-8750.090-2



D-4/03 English



CAUTION!

- Remove power to unit before wiring input and output connections.
- Follow instructions carefully to avoid personal injury.

Contents

1. Installation
2. Specifications
3. Electrical Connections
4. Menu Functions



1. Installation

ProcessPro transmitters are available in two styles: panel mount and field mount. The panel mount is supplied with the necessary hardware to install the transmitter. This manual includes complete panel mounting instructions.

Field mounting requires a separate mounting kit. The 3-8050 Universal kit enables the transmitter to be installed virtually anywhere. Detailed instructions for field installation options are included with the 3-8050 Universal kit.

1.1 Panel Installation

1. The panel mount transmitter is designed for installation using a 1/4 DIN Punch. For manual panel cutout, an adhesive template is provided as an installation guide. Recommended clearance on all sides between instruments is 1 inch.
2. Place gasket on instrument, and install in panel.
3. Slide mounting bracket over back of instrument until quick-clips snap into latches on side of instrument.
4. To remove, secure instrument temporarily with tape from front or grip from rear of instrument. **DO NOT RELEASE.** Press quick-clips outward and remove.

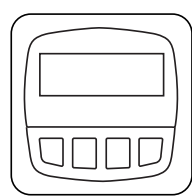

FRONT VIEW
Field Mount & Panel Mount

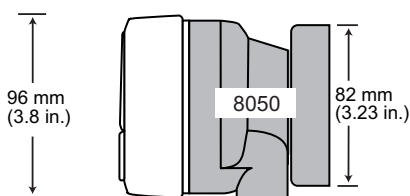

SIDE VIEW
Field Mount

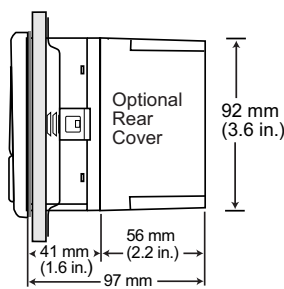

SIDE VIEW
Panel Mount

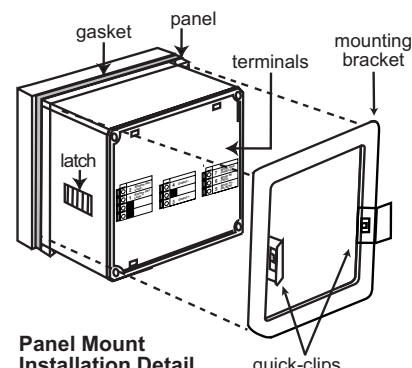

Panel Mount
Installation Detail

2. Specifications

General

Compatible electrodes: +GF+ SIGNET Twist-Lock 3-2720 pH/ORP Pre-amplifier/3-271X Electrodes

Accuracy: ± 0.03 pH, ± 2 mV's ORP

Enclosure:

- Rating: NEMA 4X/IP65 front
- Case: PBT
- Panel case gasket: Neoprene
- Window: Polyurethane coated polycarbonate
- Keypad: Sealed 4-key silicone rubber
- Weight: Approx. 325g (12 oz.)

Display:

- Alphanumeric 2 x 16 LCD
- Contrast: User selected, 5 levels
- Update rate: 1 second

Electrical

Power: 12 to 24 VDC $\pm 10\%$, regulated, 220 mA max.

Sensor input range:

- pH: 0.00 to 14.00 pH
- Temp. (pH only) 3K Balco, -25 to 120°C (-13 to 248°F)
- ORP: -1000 to +2000 mV, isolated (10K Ω I.D. resistance T+, T-)

Current output:

- 4 to 20 mA, isolated, fully adjustable and reversible

- Max loop impedance: 50 Ω max. @ 12 V
325 Ω max. @ 18 V
600 Ω max. @ 24 V
- Update rate: 0.5 seconds
- Accuracy: ± 0.03 mA @ 25°C, 24 V
- Relay outputs (2 sets mechanical SPDT contacts):
- Maximum voltage rating: 5 A @ 30 VDC, or 5 A @ 250 VAC resistive load
- Hi or Lo programmable with adjustable hysteresis
- Pulse programmable (maximum 400 pulses/minute)

Environmental

- Operating temperature: -10 to 70°C (14 to 158°F)
- Storage temperature: -15 to 80°C (5 to 176°F)
- Relative humidity: 0 to 95%, non-condensing
- Maximum altitude: 2000 m (6562 ft)
- Insulation category: II
- Pollution degree: 2

Standards and Approvals

- CSA, CE, UL listed
- Immunity: EN50082-2
- Emissions: EN55011 Class B
- Manufactured under ISO 9001 and ISO 14001

3. Electrical Connections



Caution: Failure to fully open terminal jaws before removing wire may permanently damage instrument.

Wiring Procedure

1. Remove 0.5 - 0.625 in. (13-16 mm) of insulation from wire end.
2. Press the orange terminal lever downward with a small screwdriver to open terminal jaws.
3. Insert exposed (non-insulated) wire end in terminal hole until it bottoms out.
4. Release orange terminal lever to secure wire in place. Gently pull on each wire to ensure a good connection.

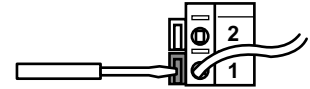

Wiring Removal Procedure

1. Press the orange terminal lever downward with a small screwdriver to open terminal jaws.
2. When fully open, remove wire from terminal.

Wiring Tips:

- Do not route sensor cable in conduit containing AC power wiring. Electrical noise may interfere with sensor signal.
- Routing sensor cable in grounded metal conduit will help prevent electrical noise and mechanical damage.
- Seal cable entry points to prevent moisture damage.
- Only one wire should be inserted into a terminal. Splice double wires outside the terminal.

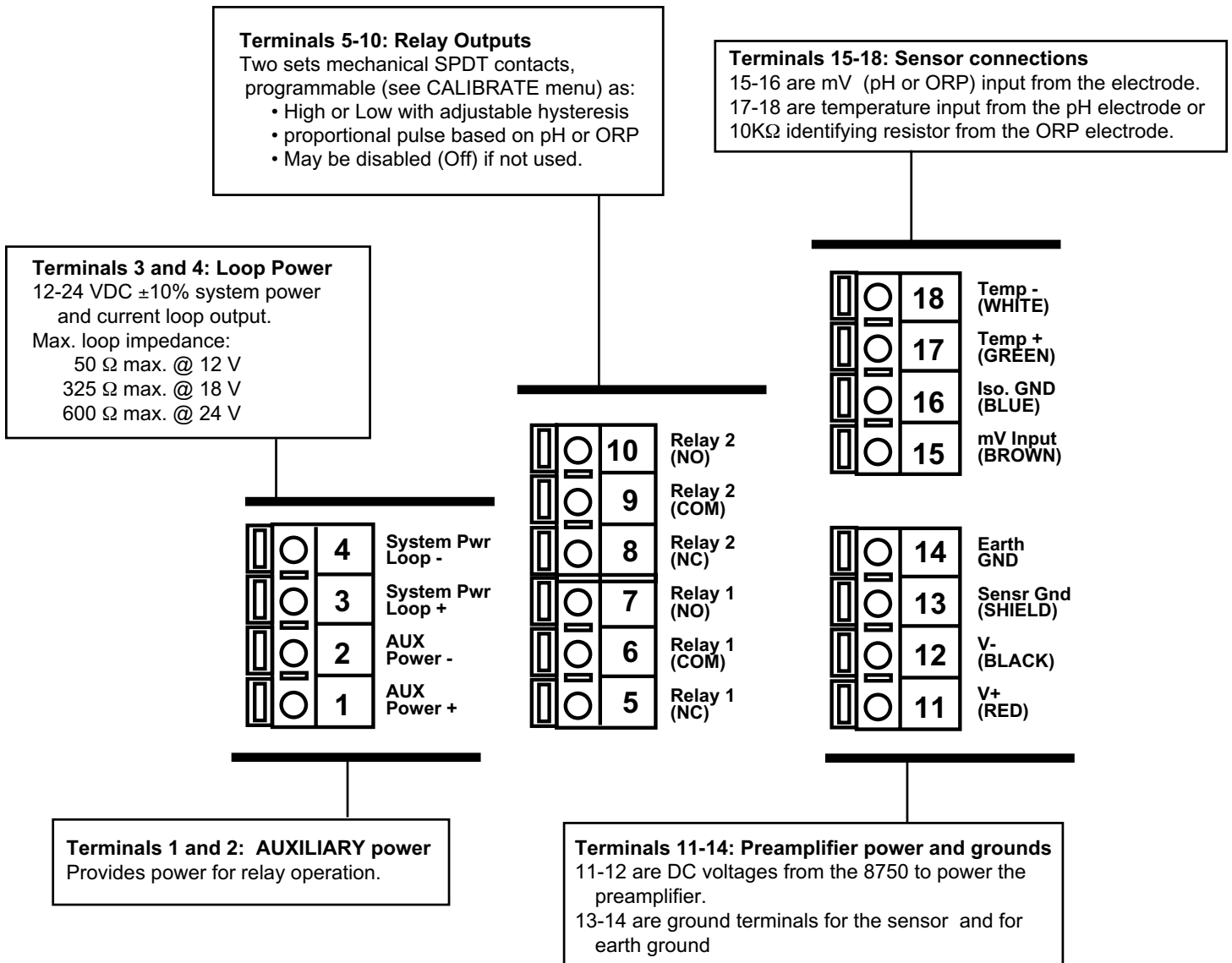

3.1 Sensor Input Connections

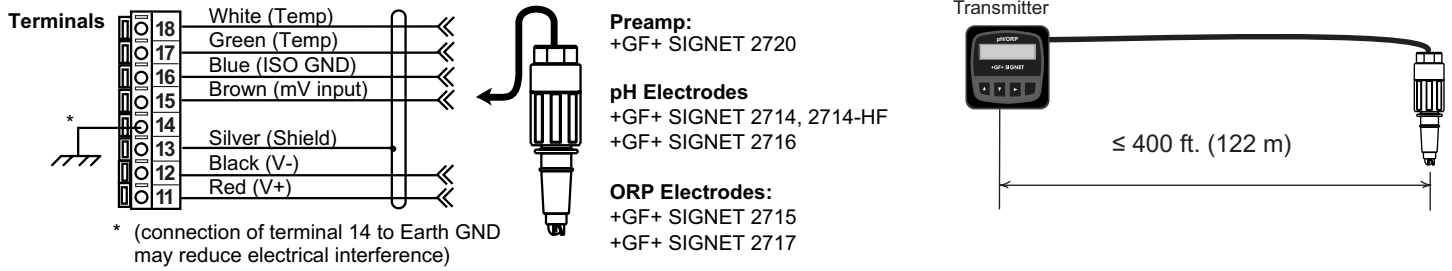

3.2 System Power/Loop Connections

Stand-alone application, no current loop used

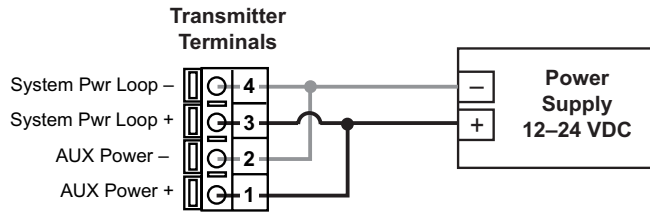

Connection to a PLC/Recorder, separate supply

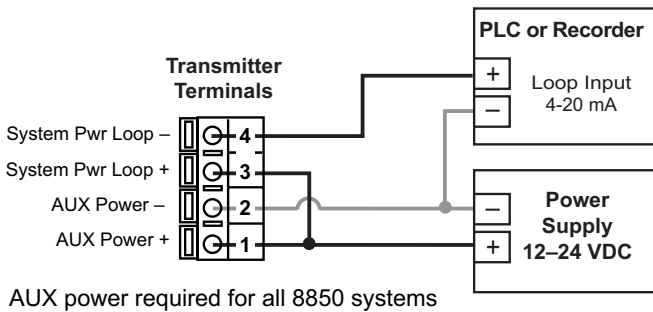

Connection to a PLC with built-in power supply

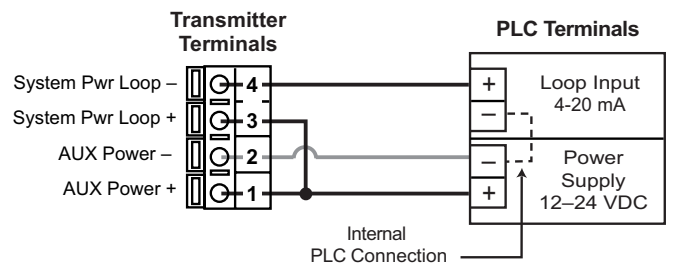

Example: Two transmitters connected to PLC/Recorder with separate power supply

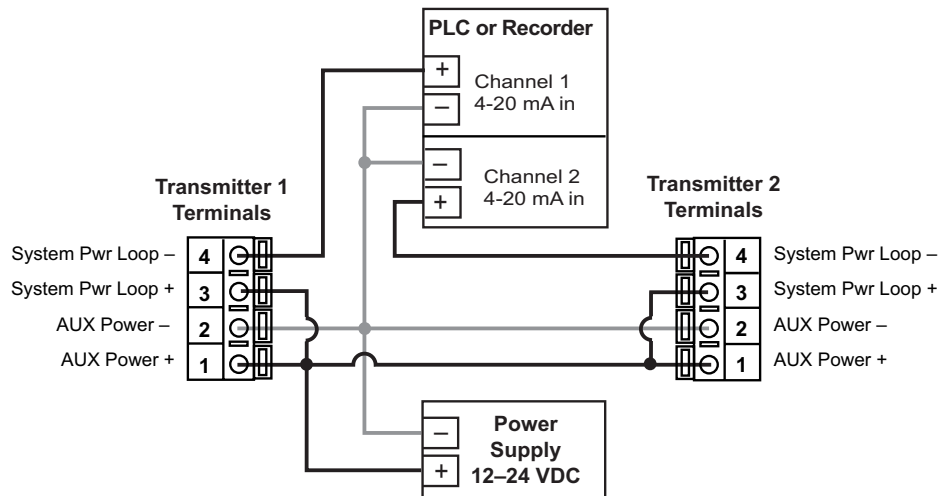

3.3 Open Collector Output

The relay outputs can be programmed to respond when the pH/ORP value moves above or below a setpoint, or it can be used to generate a pulse that is proportional to the pH/ORP value. The relays can be disabled if not in use.

- **Low**

Relay triggers when the pH/ORP is less than the setpoint. The relay will relax when the pH/ORP moves above the setpoint plus the hysteresis value.

- **High**

Relay triggers when the pH/ORP is greater than the setpoint. The relay will relax when the pH/ORP drops below the setpoint plus the hysteresis value.

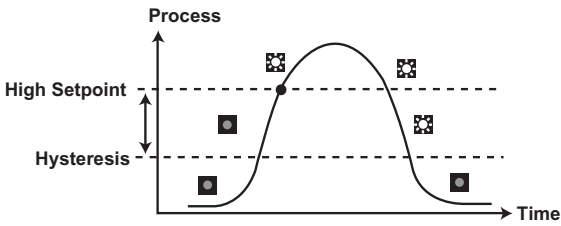
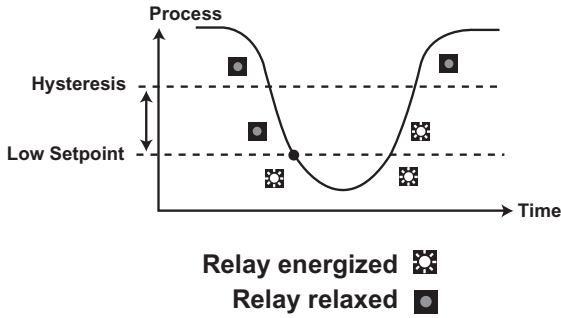

- **Proportional Pulsing**

The relay output will generate a 100 mS pulse at the rate defined by settings in the CALIBRATE menu (see page 6)

In the example below:

- The output will be 0 pulses/min. at pH values less than 5.0.
- The output will be 50 pulses/min. at 7.5 pH.
- The output will be 100 pulses/min. at pH values above 10 pH.

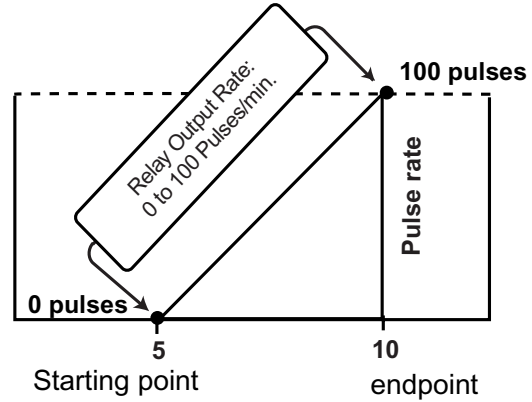

VIEW menu

- During normal operation, ProcessPro displays the VIEW menu.
- When using the CALIBRATE or OPTIONS menus, ProcessPro will return to the VIEW menu if no activity occurs for 10 minutes.
- To select the item you want displayed, press the UP or DOWN arrow keys. The items will scroll in a continuous loop. Changing the display selection does not interrupt system operations.
- No key code is necessary to change display selection.
- Output settings cannot be edited from the VIEW menu.



View Menu for pH

Display	Description
7.00 pH 12.6 °C	Monitor the Temperature input from the sensor. This is the Permanent display.

All of the VIEW displays below are temporary. The permanent display will return after ten minutes.

Input: 307 mV	Monitor the millivolt input from the electrode. Use this display to determine the relative condition of your electrode during periodic calibration. (7 pH buffer = 0 mV, ±50 mV)
Loop Output: 14.16 mA	Monitor the 4-20 mA Loop output.
Last CAL: 06-30-00 >	Monitor date for scheduled maintenance or date of last calibration.
EASY CAL: CAL: >	Easy Cal is the fastest and simplest periodic calibration method. Requires 4 pH, 7 pH and 10 pH. (Any two)

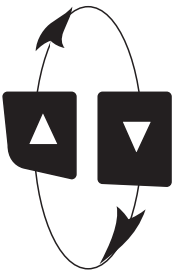

ProcessPro Editing Procedure:

Step 1. Press and hold ENTER key:

- 2 seconds to select the CALIBRATE menu
- 5 seconds to select the OPTIONS menu.

Step 2. The Key Code is UP-UP-UP-DOWN keys in sequence.

- After entering the Key Code, the display will show the first item in the selected menu.

Step 3. Scroll menu with UP or DOWN arrow keys.

Step 4. Press RIGHT ARROW key to select menu item to be edited.

- The first display element will begin flashing.

Step 5. Press UP or DOWN keys to edit the flashing element.

- RIGHT ARROW key advances the flashing element.

Step 6. Press ENTER key to save the new setting and return to Step 3.

Notes on Step 1:

- The View Menu is normally displayed.
- The CALIBRATE and OPTIONS menus require a KEY CODE.

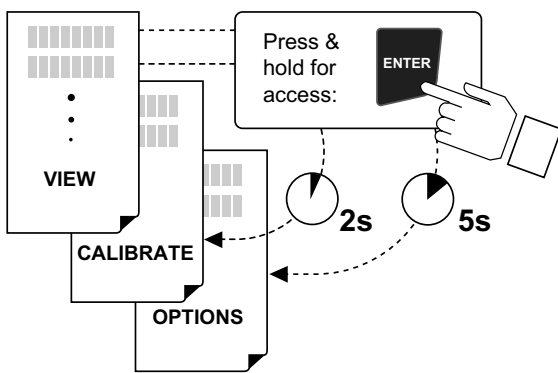

Notes on Step 2:

If no key is pressed for 5 minutes while display is showing "Enter Key Code", the display will return to the VIEW menu.

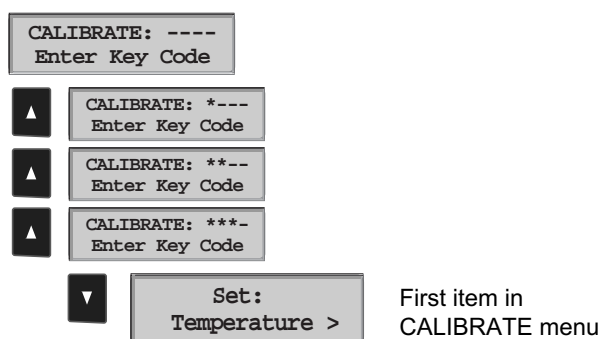

Notes on Steps 3 and 4:

- Refer to pages 6 and 7 for complete listing of menu items and their use.
- From the Step 3 display, pressing the UP and DOWN keys simultaneously will return the display to the VIEW menu.
- If no key is pressed for 10 minutes, display will also return to the VIEW menu.

Step 3: Finished Editing?
Press the UP and DOWN keys simultaneously after saving the last setting to return to normal operation.

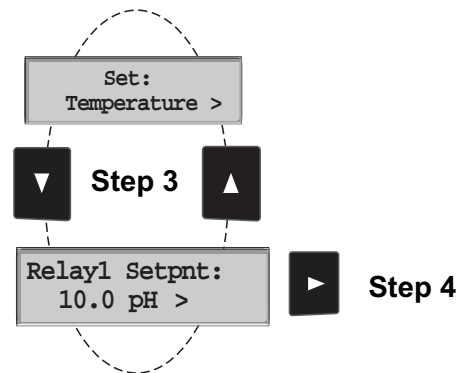

Notes on Steps 5 and 6:

- All output functions remain active during editing.
- Only the flashing element can be edited.
- RIGHT ARROW key advances the flashing element in a continuous loop.
- Edited value is effective immediately after pressing ENTER key.
- If no key is pressed for 10 minutes unit will restore the last saved value and return to step 3.
- Step 6 (pressing ENTER key) always returns you to Step 3.
- Repeat steps 3-6 until all editing is completed.

Step 5: Made an Error?

Press the UP and DOWN keys simultaneously while any element is flashing. This will recall the last saved value of the item being edited and return you to Step 3.

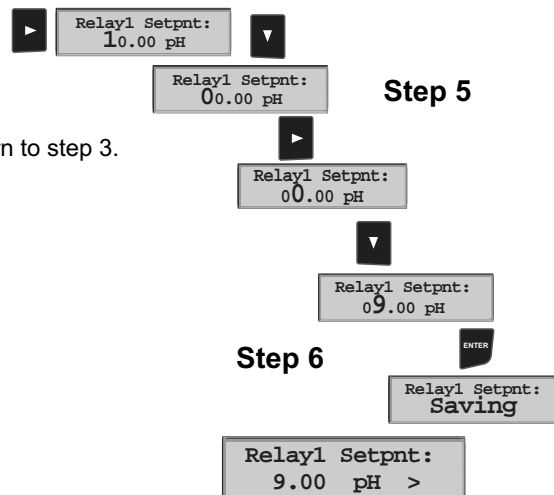

Calibrate Menu for pH





Display (Factory settings shown)	Description
Set: Temperature > 0.00 >	Provides a maximum 25°C offset to match temperature measurement to external reference.
Set: Standard > 0.00 >	Applies a linear offset to the pH measurement. The ideal value is the average pH of your application. (A sample of your application at process temperature is recommended.)
Set: Slope > 0.00 >	Applies a slope to the pH measurement. The slope value and the standard value must be at least 2 pH units apart. The ideal values are the minimum and maximum values of your process.
Loop Range: pH 0.00 → 14.00 >	Select the minimum and maximum values for the 4-20 mA Current loop output.
Relay1 Source: pH >	Select pH or Temperature as the source for this relay.
Relay1 Mode: Off >	Select the mode of operation for this relay: High, Low or proportional Pulse. The signal may be disabled if not in use.
Relay1 Setpnt: 4.00 pH >	In Low or High Mode, the relay will be activated when the pH reaches this value.
Relay1 Hys: 0.51 pH >	In Low or High mode, the relay will be deactivated at Setpoint ± Hysteresis, depending on High or Low Setpoint selection. (See details on page 4.)
Relay1 Range: 4.00 → 8.00 >	If Relay 1 is in PULSE mode, set the start and end point of the range and also set the maximum pulse rate. (The maximum PULSE rate setting is 400 pulses per minute.) The combined Relay1 Range and Relay1 Pulse rate settings shown here indicate: "Start pulsing when the pH value is 4 and increase the pulse rate up to the maximum of 120 pulses per minute when the pH value reaches 8"
Relay1 PlsRate: 120 Pulses/min >	
Last CAL: 06-30-01 >	Use this "note pad" to record important dates, such as annual recertification or scheduled maintenance.

EASY CAL Procedure - pH

- This procedure simplifies system calibration using standard 4.0, 7.0, 10.0 pH buffers only. If these pH buffers are not available, calibrate the system via the CALIBRATE menu, using the STANDARD and SLOPE settings.
- Access the CALIBRATE menu and set sensor temperature before performing EASY CAL for new electrode installations.
- Access EASY CAL menu from the view menu.

EASY CAL: ----
Enter Key Code

Press UP, UP, UP, DOWN buttons in sequence to enter menu,
XXXX will appear during code entry.

To Calibrate:	Response:	To Accept:
<p>Place Sensor in pH Buffer #1</p>  <p>Place electrode tip in first pH buffer pH 7.0 = 0 mV pH 4.0 = 177 pH 10 = -177 Limit ± 50 mV</p>	<p>6.90 pH -005 mV</p> <p>Allow for stabilization</p>  <p>30 seconds*</p>	<p>6.90 pH -005 mV</p> <p>ENTER to accept</p> <p>7.00 pH -005 mV</p>
<p>Place Sensor in pH Buffer #2</p>  <p>Place electrode tip in second pH buffer.</p>	<p>3.93 pH +179 mV</p> <p>Allow for stabilization</p>  <p>30 seconds*</p>	<p>3.93 pH +179 mV</p> <p>Press ENTER to accept second buffer calibration.</p> <p>4.00 pH +179 mV</p>
<p>To exit menus and return to VIEW press UP and DOWN button at the same time</p> 	<p>Display returns to VIEW Menu in 10 minutes or when ENTER is pressed</p>	<p>Good Easy Cal Press <ENTER></p>

Theoretical mV values

pH @ 25°C	mV
2	+296
3	+237
4	+177
5	+118
6	+59
7	+0
8	-59
9	-118
10	-177
11	-237
12	-296

Options Menu for pH

Display (Factory settings shown)	Description
<p>Contrast: 3 ></p>	Adjust the LCD contrast for best viewing. A setting of 1 is lower contrast, 5 is higher. Select lower contrast if the display is in warmer ambient surroundings.
<p>Averaging: Off ></p>	OFF provides the most instantaneous output response to changes in input value. LOW averaging = 4 seconds, HIGH averaging = 8 seconds of input signal.
<p>Temp Display: °C ></p>	Select temperature units: °C or °F.
<p>Loop Adjust: 4.00 mA ></p>	Adjust the minimum and maximum current output. The display value represents the precise current output. Adjustment limits: • 3.80 mA < 4.00 mA > 5.00 mA • 19.00 mA < 20.00 mA > 21.00 ma Use this setting to match the 8750 loop output to any external device.
<p>Loop Adjust: 20.00 mA ></p>	
<p>Test Loop: ></p>	Press UP or DOWN keys to manually order any output current value from 3.6 mA to 21.00 mA to test current loop output.
<p>Test Relay 1: ></p>	Press UP or DOWN keys to manually toggle the state of the relay output.
<p>Test Relay 2: ></p>	Press UP or DOWN keys to manually toggle the state of the relay output.

Calibrate Menu for ORP





Display (Factory settings shown)	Description
Set: Standard >	Applies a linear offset to the ORP measurement. If you are using a single-point calibration, use this function. The ideal value is the average pH of your application. (A sample of your application at process temperature is recommended.)
Set: Slope >	Applies a slope to the ORP measurement. This function should only be used in a two-point calibration. The slope value and the standard value must be at least 2 pH units apart. The ideal values are the minimum and maximum values of your application.
Loop Range: mV -1000 > +1000 >	Select the minimum and maximum ORP values for the 4-20 mA Current loop output. Maximum settings are -1000 mV to +2000 mV.
Relay1 Mode: Off >	Select the mode of operation for this relay: High, Low or proportional Pulse. The signal may also be disabled if not in use.
Relay1 Setpnt: -500 mV >	In Low or High Mode, the relay will be activated when the ORP reaches this value.
Relay1 Hys: 10 mV >	In Low or High mode, the relay will be deactivated at Setpoint ± Hysteresis, depending on High or Low Setpoint selection. (See details on page 4.)
Relay1 Range: mV -500 → +500 >	If Relay 1 is in PULSE mode, set the start and end point of the range and also set the maximum pulse rate. (The maximum PULSE rate setting is 400 pulses per minute.)
Relay1 PlsRate: 120 pulses/min >	
Last Cal: 06-30-01 >	Use this "note pad" to record important dates, such as annual recertification or scheduled maintenance.

EASY CAL Procedure - ORP

- This procedure simplifies system calibration using standard 4.0 pH and 7.0 pH buffers **saturated with Quinhydrone**. To calibrate using any other ORP buffer solutions, use the Standard and Slope functions in the CALIBRATE menu.
- Access EASY CAL menu from the view menu.

EASY CAL: ----
Enter Key Code

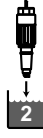
Press UP, UP, UP, DOWN buttons in sequence to enter menu,
*** will appear during code entry.

To Calibrate:	Response:	To Accept:
<p>Place Sensor in ORP Buffer #1</p>  <p>Place electrode tip in first pH buffer;</p> <p>pH 7.0 ≈ 87 mV pH 4.0 ≈ 264 mV</p>	<p>* ORP: + 84 mV Input: + 82 mV</p> <p>Allow for stabilization</p>  <p>30 seconds*</p>	<p>* ORP: + 84 mV Input: + 82 mV</p> <p>ENTER to accept</p> <p>* ORP: + 87 mV Input: + 82 mV</p>
<p>Place Sensor in ORP Buffer #2</p>  <p>Place electrode tip in second (different) pH buffer.</p> <p>pH 4.0 ≈ 264 mV pH 7.0 ≈ 87 mV</p>	<p>* ORP: +262 mV Input: +260 mV</p> <p>Allow for stabilization</p>  <p>30 seconds*</p>	<p>* ORP: +262 mV Input: +260 mV</p> <p>Press ENTER to accept second buffer calibration.</p> <p>* ORP: +264 mV Input: +260 mV</p>
<p>To exit menus and return to VIEW press UP and DOWN button at the same time</p> 	<p>Display returns to VIEW Menu in 10 minutes or when ENTER is pressed</p>	<p>Good Easy Cal Press <ENTER></p>

* For best results, gently stir the submerged electrode for approximately 5 seconds during the stabilization period. Large temperature differences from process fluids to buffers may require longer stabilization time.

Technical notes:

The difference between the actual mV and value shown is a good indication of the condition of the electrode. Differences in excess of 50 mV may indicate a need to service the electrode.

Options Menu for ORP

Display (Factory settings shown)	Description
<p>Contrast: 3 ></p>	Adjust the LCD contrast for best viewing. A setting of 1 is lower contrast, 5 is higher. Select lower contrast if the display is in warmer ambient surroundings.
<p>Averaging: Off ></p>	OFF provides the most instantaneous output response to changes in input value. LOW averaging = 4 seconds, HIGH averaging produces more stable display and output response.
<p>Loop Adjust: 4.00 mA ></p>	<p>Adjust the minimum and maximum current output. The display value represents the precise current output.</p> <p>Adjustment limits:</p> <ul style="list-style-type: none"> 3.80 mA < 4.00 mA > 5.00 mA 19.00 mA < 20.00 mA > 21.00 ma <p>Use this setting to match the 8750 loop output to any external device.</p>
<p>Loop Adjust: 20.00 mA ></p>	
<p>Test Loop: ></p>	Press UP or DOWN keys to manually order any output current value from 3.6 mA to 21.00 mA to test current loop output.
<p>Test Relay 1: ></p>	Press UP or DOWN keys to manually toggle the state of the relay.
<p>Test Relay 2: ></p>	Press UP or DOWN keys to manually toggle the state of the relay.

Troubleshooting - pH

Display Condition	Possible causes	Suggested Solutions
During EasyCal: "Out of Range Use Manual CAL"	<ol style="list-style-type: none"> 1. Required 4, 7 or 10 buffers not being used. 2. Sensor is depleted too severely to use EasyCal. 	<ol style="list-style-type: none"> 1. Use pH 4, 7, 10 buffers. 2. Clean probe and retry EASY CAL. 3. Use Manual calibration for Standard and Slope if mV offset exceeds 50 mV.
During EasyCal: "Same Buffer"	Sensor was not moved from buffer #1 to buffer #2.	<ol style="list-style-type: none"> 1. Place sensor in correct buffer solution. 2. Use fresh buffer.
During CALIBRATE Std: "Standard too close to Slope!"	<ol style="list-style-type: none"> 1. pH Standard value within 2 pH units of Slope value. 2. pH Sensor efficiency is inadequate. 	<ol style="list-style-type: none"> 1. Use pH values at least 2 pH units apart. 2. Clean pH sensor; replace if necessary. 3. Use fresh buffer.
During CALIBRATE Slope: "Slope too close to Standard!"	<ol style="list-style-type: none"> 1. pH Slope value within 2 pH units of Standard value. 2. pH Sensor efficiency is inadequate. 	<ol style="list-style-type: none"> 1. Use pH values at least 2 pH units apart. 2. Clean pH sensor; replace if necessary 3. Use fresh buffer.
During CALIBRATE: "Out of Range Check Sensor"	<ol style="list-style-type: none"> 1. No temperature or mV signal from sensor detected. 2. No connection between pH sensor and preamplifier. 	<ol style="list-style-type: none"> 1. Check all wiring, contacts in preamplifier. 2. Verify sensor is securely installed. 3. Replace electrode pH sensor.
During normal operation: Constant "15.00 pH" or constant "0.00 pH" with good temp value	mV input is less than 0 pH or greater than 15 pH.	<ol style="list-style-type: none"> 1. Recalibrate system. 2. Replace pH sensor. 3. Replace preamplifier.
During normal operation: "Check Sensor?"	<ol style="list-style-type: none"> 1. No temperature or mV signal from sensor detected. 2. No connection between pH sensor and preamplifier. 	<ol style="list-style-type: none"> 1. Check all wiring, contacts in preamplifier. 2. Verify sensor is securely installed. 3. Replace pH sensor.

The mV value from the sensor when placed in a 7 pH buffer represents the sensor offset. Signet recommends servicing/replacing the sensor when the offset exceeds 50 mV.

The 3-2759 pH/ORP system tester allows simple system troubleshooting.

Troubleshooting - ORP

Display Condition	Possible causes	Suggested Solutions
During EasyCal: "Out of Range Use Manual CAL"	<ol style="list-style-type: none"> Required 4, 7 buffers with quinhydrone not being used. Sensor is depleted too severely to use EasyCal. 	<ol style="list-style-type: none"> Use pH 4, 7 buffers saturated with quinhydrone. Clean probe and retry EASY CAL. Use Manual calibration for Standard and Slope if mV offset exceeds 50 mV.
During EasyCal: "Same Buffer"	Sensor was not moved from buffer #1 to buffer #2.	<ol style="list-style-type: none"> Place sensor in correct buffer solution. Use fresh buffer.
During CALIBRATE Std: "Standard too close to Slope!"	<ol style="list-style-type: none"> ORP Standard value within 120 mV of Slope value. ORP Sensor efficiency is inadequate. 	<ol style="list-style-type: none"> Use ORP values at least 120 mV apart. Clean ORP sensor; replace if necessary. Use fresh buffer.
During CALIBRATE Slope: "Slope too close to Standard!"	<ol style="list-style-type: none"> ORP Slope value within 120 mV of Standard value. ORP Sensor efficiency is inadequate. 	<ol style="list-style-type: none"> Use ORP values at least 120 mV apart. Clean ORP sensor; replace if necessary Use fresh buffer.
During CALIBRATE: "Out of Range Check Sensor"	<ol style="list-style-type: none"> No mV signal or sensor id from sensor detected. No connection between ORP sensor and preamplifier. 	<ol style="list-style-type: none"> Check all wiring, contacts in preamplifier. Verify sensor is securely installed. Replace ORP sensor.
During normal operation: Constant "-1000" or constant ""+2000"	mV input is less than -999 or greater than +1999.	<ol style="list-style-type: none"> Recalibrate system. Replace pH sensor. Replace preamplifier.
During normal operation: "Check Sensor?"	<ol style="list-style-type: none"> No temperature or mV signal from sensor detected. No connection between ORP sensor and preamplifier. 	<ol style="list-style-type: none"> Check all wiring, contacts in preamplifier. Verify sensor is securely installed. Replace ORP sensor.

Ordering Information

Mfr. Part No.	Code	Description
3-8750-1	159 000 053	pH/ORP transmitter Field mount
3-8750-1P	159 000 054	pH/ORP transmitter Panel mount
3-8750-2	159 000 055	pH/ORP transmitter Field mount with relays
3-8750-2P	159 000 056	pH/ORP transmitter Panel mount with relays
3-8750-3	159 000 057	pH/ORP transmitter Field mount with single input/dual output
3-8750-3P	159 000 058	pH/ORP transmitter Panel mount with single input/dual output

Accessories

Mfr. Part No.	Code	Description
3-2714	198 844 300	Twist-Lock Flat pH electrode
3-2714-HF	198 844 305	Twist-Lock Flat pH hydrofluoric acid resistant electrode (<2%)
3-2716	198 844 302	Twist-Lock Bulb pH electrode
3-2716-DI	198 844 306	Twist-Lock Bulb pH electrode for process liquids (< 100 µs)
3-2715	198 844 301	Twist-Lock Flat ORP Electrode
3-2717	198 844 303	Twist-Lock Bulb ORP Electrode
3-2720	198 864 602	Twist-Lock Preamplifier, 1/4 in. NPT
3-2720-2	198 864 603	Twist-Lock Preamplifier, ISO 7/1-R 3/4
P31542	198 801 630	Red sensor cap for in-line installations
P31542-3	159 000 464	Blue sensor cap for in-line installations
3-2759	159 000 762	pH/ORP system tested (includes bypass adapter)
3-2759.393	159 000 765	2720 Adapter Cable
P31515-0P200	159 000 630	PVC Pipe Adapter
P31515-0C200	159 000 631	CPVC Pipe Adapter
P31515-0V200	159 000 459	PVDF Pipe Adapter
1220-0021	198 801 186	O-ring, FPM (standard)
1224-0021	198 820 006	O-ring, EPR
1228-0021	198 820 007	O-ring, Kalrez®
3-8050	159 000 184	Universal mounting kit
3-8050.395	159 000 186	Splashproof rear cover
3-8050.396	159 000 617	RC Filter kit (for relay use)
3-8052	159 000 188	3/4" Integral mounting kit
3-8052-1	159 000 755	3/4" NPT mount junction box
3-0000.596	159 000 641	Heavy duty wall mount bracket
3-0700.390	198 864 403	pH buffer kit
3-8050.392	159 000 640	Model 200 retrofit adapter
3-5000.598	198 840 225	Surface mount bracket
3-5000.399	198 840 224	5 x 5 inch adapter plate for +GF+ Signet retrofit
3-9000.392	159 000 368	Liquid-tight connector kit, 3 sets, 1/2 in. NPT
3-9000.392-1	159 000 839	Liquid-tight connector kit, 1 set, 1/2 in. NPT
3-9000.392-2	159 000 841	Liquid-tight connector kit, 1 set, PG 13.5
7300-7524	159 000 687	24 VDC Power Supply 7.5 W, 300mA
7300-1524	159 000 688	24 VDC Power Supply 15 W, 600mA
7300-3024	159 000 689	24 VDC Power Supply 30 W, 1.3 A
7300-5024	159 000 690	24 VDC Power Supply 50 W, 2.1 A
7300-1024	159 000 691	24 VDC Power Supply 100 W, 4.2 A
3-3719-11	159 000 804	pH/ORP Wet-Tap, 1 1/2 in. NPT
3-3719-21	159 000 805	pH/ORP Wet-Tap, 2 in. NPT
3-3719-12	159 000 806	pH/ORP Wet-Tap, ISO 7/1-R 1.5
3-3719-22	159 000 807	Wet-Tap Assembly, ISO 7/1-R 2
3-2716-WT	159 000 809	Twist-Lock pH Electrode (use with 3719 Wet-Tap)
3-2717-WT	159 000 811	Twist-Lock ORP Electrode (use with 3719 Wet-Tap)
2007-0225	159 000 812	PP Clamp-on Saddle, 2.5 in. x 1 1/2 in. (ASTM, NPT)
2007-0230	159 000 813	PP Clamp-on Saddle, 3 in. x 1 1/2 in. (ASTM, NPT)
2007-0240	159 000 814	PP Clamp-on Saddle, 4 in. x 1 1/2 in. (ASTM, NPT)
2007-0260	159 000 815	PP Clamp-on Saddle, 6 in. x 2 in. (ASTM, NPT)
2007-0280	159 000 816	PP Clamp-on Saddle, 8 in. x 2 in. (ASTM, NPT)
2007-0210	159 000 817	PP Clamp-on Saddle, 10 in. x 2 in. (ASTM, NPT)
2007-0212	159 000 818	PP Clamp-on Saddle, 12 in. x 2 in. (ASTM, NPT)

+GF+ SIGNET

Signet Scientific Company, 3401 Aerojet Avenue, El Monte, CA 91731-2882 U.S.A. • Tel. (626) 571-2770 • Fax (626) 573-2057
For Worldwide Sales and Service, visit our website: www.gfsignet.com • Or call (in the U.S.): (800) 854-4090

