

Operator's Manual

CRAFTSMAN®

12 AMP Motor

195 MPH/405 CFM

ELECTRIC BLOWER/VACUUM

Model No.

358.799380

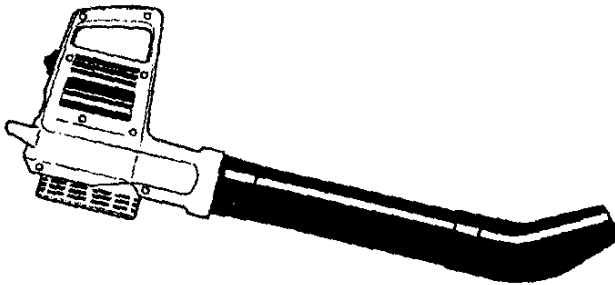

FOR HOUSEHOLD USE



WARNING:

Read and follow all Safety Rules and Operating Instructions before first use of this product.



For answers to your questions about this product, call 7am-7pm, Mon.-Sat., or 10am-7pm, Sun.

1-800-235-5878 (Hours listed are Central Time)

Sears, Roebuck and Co., Hoffman Estates, IL 60179 USA

530087635 10/26/99

SAFETY

ASSEMBLY

OPERATION

MAINTENANCE

ESPAÑOL

TABLE OF CONTENTS

Warranty Statement	2	Storage	10
Safety Rules	2	Troubleshooting Chart	10
Assembly	5	Parts Available	10
Operation	8	Spanish	11
Maintenance	9	Parts Ordering	Back Cover
Service & Adjustments	10		

WARRANTY STATEMENT

FULL ONE YEAR WARRANTY ON SEARS CRAFTSMAN ELECTRIC BLOWER

If this Craftsman Electric Blower fails to perform properly due to a defect in material or workmanship within (1) one year from the date of purchase, Sears will repair or replace it, free of charge.

WARRANTY SERVICE IS AVAILABLE BY RETURNING THE CRAFTSMAN ELECTRIC BLOWER TO THE NEAREST SEARS STORE IN THE UNITED STATES.

This warranty gives you specific legal rights, and you may also have other rights which vary from state to state.

Sears, Roebuck and Co. D/817WA Hoffman Estates, IL 60179

SAFETY RULES

IMPORTANT WARNINGS AND SAFETY INSTRUCTIONS

⚠ WARNING: When using electric gardening appliances, basic safety precautions should always be followed to reduce the risk of fire, electric shock, and serious injury.

⚠ WARNING: The warnings and safety instructions in this manual must be followed to reduce the risk of fire, electric shock, or injury, and to provide reasonable safety and efficiency in using this unit. The operator is responsible for following the warnings and instructions in this manual and on the unit. Read the entire Operator's Manual before assembling and using the unit! Restrict the use of this unit to persons who read, understand, and follow the warnings and instructions in this manual and on the unit. Never allow children to use this unit. Close attention is necessary when used near children.

OPERATOR SAFETY

- Always wear safety glasses or similar eye protection when operating, servicing, or performing maintenance on your unit. Wearing eye protection can help to prevent rocks or debris from being blown or ricocheting into eyes

and face which can result in blindness or serious injury.

- Always wear a respirator or facemask when working with the unit in dusty environments.
- Dress safely in long pants. Do not go barefoot or wear short pants or sandals.
- Do not operate the unit when you are tired, ill, upset, or if you are under the influence of alcohol, drugs, or medication.
- Secure hair so it is above shoulder length. Keep loose hair, loose clothing, fingers, and all other parts of the body away from openings and moving parts. Hair, jewelry, loose clothing, or clothing with loosely hanging straps, ties, tassels, etc., can be caught in moving parts.

ELECTRICAL SAFETY

- Use only a voltage supply as shown on the name plate of the unit.
- Avoid dangerous situations. Do not use in presence of flammable liquids or gases to avoid creating a fire or explosion and/or causing damage to unit.
- Avoid dangerous environments. Do not use in unventilated areas or where dust or explosive vapors can build up.

- **TO REDUCE THE RISK OF ELECTRICAL SHOCK**--Do not use in damp or wet locations or around swimming pools, hot tubs, etc. Do not expose to snow, rain, or water. Do not handle extension cord plug or unit with wet hands.
- To reduce the risk of electrical shock, use extension cords specifically marked as suitable for outdoor appliances having electrical rating not less than the rating of the unit. The cord must be marked with the suffix "W-A" (in Canada, "W"). Use a polarized cord. Make sure your extension cord is in good condition. If damaged, have the cord replaced. An undersized extension cord will cause a drop in line voltage resulting in loss of power and overheating. If in doubt, use the next heavier gauge. The smaller the gauge number, the heavier the cord. (NOTE: The correct size to be used depending on the cord length is shown in this manual).
- To reduce the risk of electrical shock, this equipment has a polarized plug (one blade is wider than the other). This plug will fit only one way in a polarized outlet of the extension cord. Ensure you have a polarized extension cord. The plug of the polarized extension cord will fit into the outlet only one way. If the plug does not fit fully in the outlet, reverse the plug. If it still does not fit, contact a qualified electrician to install proper outlet. Do not change the plug in any way.
- Inspect the insulation and connectors on the unit and extension cord before each use. If there is any damage, do not use until damage is repaired by your Sears Service Center. Do not pull or carry by cord; do not use cord as a handle, close a door on cord, or pull cord around sharp edges or corners. Keep cord away from heated surfaces. Do not unplug by pulling on cord. To unplug, grasp the plug, not the cord.
- To reduce the possibility of the extension cord disconnecting from the unit during operation, tie cord to cord retainer and connect to recessed plug as shown in this manual.
- Don't use the unit if the switch does not turn the unit on and off properly. Have the unit repaired by your Sears Service Center.
- Keep the extension cord clear of operator and obstacles at all times. Do not expose cords to heat, oil, water, or sharp edges.
- Avoid any body contact with any grounded conductor, such as metal fences, or pipes, to avoid the possibility of electric shock. Don't handle plug or unit with wet hands.
- Do not use with damaged cord or plug. If unit is not working as it should, has been dropped, damaged, left outdoors, or dropped into water, return it to your Sears Service Center for repair.
- Ground Fault Circuit Interrupter (GFCI) protection should be provided on the circuit or outlet to be used for this unit. Receptacles are available having built-in GFCI protection and may be used for this measure of safety.
- Keep others including children, animals, bystanders, and helpers a minimum of 30 feet (10 meters) away. Stop the motor immediately if you are approached. Do not allow the unit to be used as a toy.

DOUBLE INSULATION CONSTRUCTION

This unit is Double Insulated to help protect against electric shock. Double insulation construction consists of two separate "layers" of electrical insulation instead of grounding. Tools and appliances built with a double insulation system are not intended to be grounded. No grounding means is provided on this unit, nor should a means of grounding be added to this unit. As a result, the extension cord used with your unit can be plugged into any standard 120 volt electrical outlet. Safety precautions must be observed when operating any electrical tool. The double insulation system only provides added protection against injury resulting from an internal electrical insulation failure.

All electrical repairs to this unit, including housing, switch, motor, etc., must be diagnosed and repaired by qualified service personnel. Replacement parts for a double insulated appliance must be identical to the parts they replace. A double insulated appliance is marked with the words DOUBLE INSULATION or DOUBLE INSULATED. The symbol  (square within a square) may also be marked on the appliance. Failure to have the unit repaired by Sears service personnel can cause the double

insulation construction to become ineffective and result in serious injury.

UNIT/MAINTENANCE SAFETY

- Turn off all controls and allow the motor to stop before disconnecting the unit from the power source.
- Disconnect the unit from the power source when not in use. Do not leave the unit when it is plugged into outlet.
- Do not set the unit on any surface except a clean, hard area while the unit is running. Debris such as gravel, sand, dust, grass, etc., could be picked up by the air intake and thrown out through the discharge opening, damaging the unit, property, or causing serious injury to bystanders or operator.
- Do not overreach or use from unstable surfaces such as ladders, trees, steep slopes, rooftops, etc. Use extra care when cleaning on stairways. Keep firm footing and balance at all times. Keep hands out of tubes.
- Inspect the entire unit before each use for worn, loose, missing, or damaged parts. Do not use until the unit is in proper working order.
- Disconnect unit from power source before servicing, cleaning, performing maintenance, or storing. This unit is Double Insulated. See the "DOUBLE INSULATION" section. Have all internal service performed by qualified service repair personnel to avoid creating a hazard or voiding your warranty.
- Have all maintenance other than the recommended procedures described in the Operator's Manual performed by your Sears Service Center.
- Always see your Sears Service Center to replace a damaged impeller. Parts that are chipped, cracked, broken, or damaged in any other way can fly apart and cause serious injury. Replace damaged parts before using the unit.
- Never place any object in the air intake opening as this could restrict proper air flow and cause damage to the unit.
- Never douse the unit with water or other liquids or squirt with a water hose. Clean with a damp sponge and mild soap. See "STORAGE."
- Check air intake openings and tubes frequently, always with the unit stopped and power source disconnected. Keep vents and tubes free of debris which can accumulate and restrict proper air flow.
- Do not burn, incinerate, or expose this unit to extreme heat.

- Store the unit unplugged in a high, cool, dry, indoor area out of the reach of children.
- Use only recommended attachments and replacement parts to avoid creating a hazard and/or voiding warranty.
- Maintain the unit according to recommended procedures.
- Use only for jobs explained in this manual.

BLOWER SAFETY

- Use only in daylight or in good artificial light.
- Inspect the area before using the unit. Remove all debris and hard objects such as rocks, glass, wire, etc., that can ricochet, be thrown, or otherwise cause injury or damage.
- Avoid accidental starting. Be sure the switch is in the OFF position and keep your hand and fingers away from the switch while connecting the unit to the power source or when carrying a unit connected to the power source.
- Never run the unit without the proper equipment attached. When used as a blower, always install a blower tube. Use only recommended attachments. Do not use with any opening blocked. Keep free of dust, lint, hair and anything that may reduce air flow.
- To avoid spreading fire, do not use blower near leaf or brush fires, fireplaces, barbecue pits, ashtrays, etc.
- Never place objects inside the blower tubes; always direct the blowing debris away from people, animals, glass, and solid objects such as trees, automobiles, walls, etc. The force of air can cause rocks, dirt, or sticks to be thrown or to ricochet which can hurt people or animals, break glass, or cause other damage.
- Never use for spreading chemicals, fertilizers, or any other substances which may contain toxic materials.

VACUUM SAFETY

- Stop the motor and disconnect the power source before opening the air inlet door or attempting to insert or remove the vacuum tubes. The motor must be stopped and the impeller blades no longer turning to avoid serious injury from the rotating blades.
- Hard objects can be thrown through the collection bag or the housing and become dangerous missiles which can cause serious injury to the operator or others.
- When using the vacuum attachment, the unit is designed to pick up dry material such as leaves, grass, small

twigs, and bits of paper. Do not vacuum stones, gravel, metal, broken glass, etc., to avoid severe damage to the impeller. To avoid the possibility of electrical shock, do not attempt to vacuum water or other liquids.

- Never run the unit without the proper equipment attached. When used as a vacuum, always install vacuum tubes and collection bag assembly. Make sure the collection bag assembly is completely zipped when unit is running to avoid flying debris. Use only recommended attachments.
- Avoid situations which could set the collection bag on fire. Do not vacuum discarded matches, cigars, cigarettes, or ash from fireplaces, barbecue pits, brush piles, etc. To avoid spreading fire, do not use blower near leaf or brush fires, fireplaces, barbecue pits, ashtrays, etc.
- Always use the collection bag shoulder strap when vacuuming to avoid loss of control.

- Check air intake openings, elbow tube, and vacuum tubes frequently, always with the unit stopped and the power source disconnected. Keep vents and tubes free of debris which can accumulate and restrict proper air flow. Do not use with any opening blocked. Keep free of dust, lint, hair and anything that may reduce air flow.

STANDARDS

This product is listed by Underwriters Laboratories, Inc., in accordance with UL Standard 1017.

If situations occur which are not covered in this manual, use care and good judgment. If you need assistance, contact your Sears Service Center or call 1-800-235-5878. Failure to follow all Safety Rules and Precautions can result in serious injury.

SAVE THESE INSTRUCTIONS

ASSEMBLY

CARTON CONTENTS

Model 358.799380

Blower

Blower Tube

Nozzle

2 Vacuum Tubes

Collection Bag

Examine parts for damage. Do not use damaged parts.

NOTE: If you need assistance or find parts missing or damaged, call 1-800-235-5878.

ASSEMBLY

⚠ WARNING: If received assembled, repeat all steps to ensure your unit is properly assembled and all fasteners are secure.

ASSEMBLY INSTRUCTIONS FOR USING YOUR UNIT AS A BLOWER

NOTE: Assembly instructions for using your unit as a vacuum follow this section.

ATTACHING THE BLOWER TUBE AND NOZZLE

If you have already assembled your unit for use as a vacuum, remove the vacuum tubes and the collection bag.

- Insert the blower tube into the blower outlet.
- Twist the blower tube clockwise until it is firmly seated in the blower outlet.
- Twist the nozzle into the end of the blower tube until it is firmly seated. Make sure the nozzle points upward.

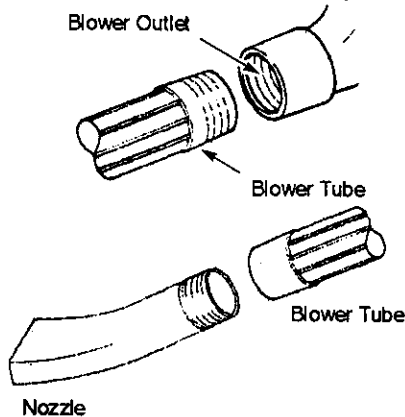

ASSEMBLY INSTRUCTIONS FOR USING YOUR UNIT AS A VACUUM

NOTE: Assembly instructions for using your unit as a blower is explained in the previous section.

⚠ WARNING: Stop the unit and disconnect from the power source before opening the inlet cover or attempting to insert or remove the inlet restrictor or vacuum tubes. The motor must be stopped and the impeller blades no longer turning to avoid serious injury from the rotating blades.

NOTE: If you have already assembled your unit for use as a blower, remove the blower tube and nozzle.

REMOVE THE INLET RESTRICTOR

An inlet restrictor is used when using your unit as a blower. This restrictor is not used during vacuum use, and must be removed during assembly for vacuum use.

NOTE: Be sure to keep the inlet restrictor for using your unit as a blower.

- Open the inlet cover by inserting the tip of a screwdriver into the inlet cover latch area, and twisting the screwdriver while pulling the inlet cover open.

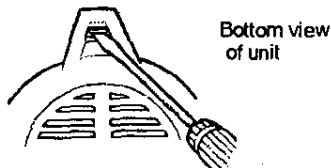

- Turn the inlet restrictor counterclockwise and remove it from the unit.

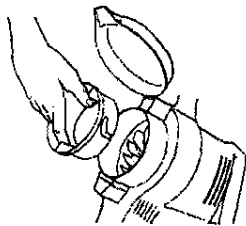

Do not close the inlet door. You will next attach the vacuum tubes.

ATTACHING THE VACUUM TUBES

There are 2 vacuum tubes, an upper and lower tube. The upper tube is cut straight on both ends, and attaches to the blower unit. The second tube is cut at an angle on the lower end. This

angled end will point toward the ground during vacuum use.

- Locate the arrows on the upper vacuum tube and on the vacuum inlet area of the unit.

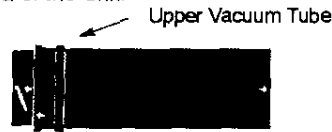

- While holding the inlet cover open, align the arrows and insert the vacuum tube into the opening. Twist the tube clockwise until it is seated. A second arrow on the vacuum tube will align with the arrow on the unit once the tube twisted completely in place.

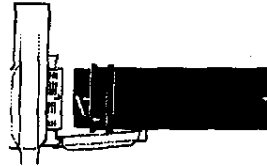

Align arrows on tube & unit

- Attach the lower vacuum tube to the upper vacuum tube by aligning the arrows on the two tubes. Press the tubes together until the lower tube is fully seated in the upper tube. (About 3 inches)

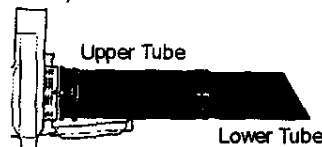

ATTACH THE COLLECTION BAG

Slide the opening of the collection bag over the blower outlet. Pull the strap with velcro tightly through the buckle and secure with velcro tabs.

NOTE: Make sure the strap with velcro is located on the blower outlet as shown. Also, make sure the zipper on the bag is completely closed.

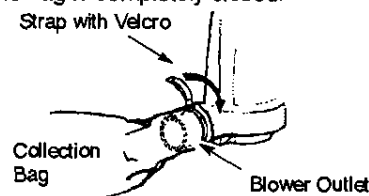

ADJUSTING THE SHOULDER STRAP ON THE COLLECTION BAG

- Carefully loop the shoulder strap through the buckle as shown in the illustration below.

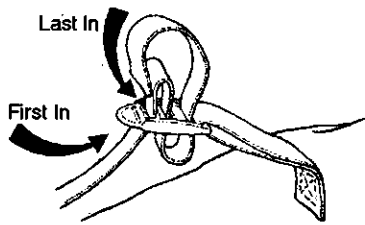

- Position the unit on your right-hand side, blower outlet and bag pointing toward the rear. Hold the unit in an upright position, and support the lower vacuum tube on the ground.
- Place the shoulder strap over your head and onto your left shoulder.
- Adjust the strap to allow a free flow of air from the blower. If the collection bag is kinked, the unit will not operate properly.

NOTE: The strap is designed to position the collection bag on your shoulder without kinks. The strap is not intended to support the weight of the unit.



HOW TO CONVERT UNIT FROM VACUUM USE TO BLOWER USE.

- Stop unit and unplug the extension cord.

- Remove the vacuum tubes and collection bag.
- Install the inlet restrictor that was removed when assembling for vacuum use.

NOTE: If you are unable to locate the inlet restrictor, the unit will still operate. This restrictor improves the blower function.

- Close the inlet cover and make sure it is latched closed.
- Re-install the blower tubes. Refer to the section ATTACHING THE BLOWER TUBE AND NOZZLE for instructions on how to attach these items.

EXTENSION CORD

Use only a 120 A.C. voltage supply as shown on nameplate of the unit to power your edger.

The extension cord used to reach the power source must be:

- Specifically marked as suitable for outdoor use. The cord must be marked with the suffix "W-A."
- Heavy enough to carry current from the power source the full length of extension cord to the unit. Otherwise, loss of power and overheating can occur causing damage to unit. Refer to chart for minimum wire gauge recommendations. The cord must be marked with the proper wire gauge. (Appropriate extension cords are available.) Do not use multiple cords.
- In good condition. Cord insulation must be intact with no cracks or deterioration. Plug connectors must be undamaged.

MINIMUM WIRE GAUGE RECOMMENDATIONS			
VOLTS	25 FT.	50 FT.	100 FT.
120	16 A.W.G.*	16 A.W.G.*	14 A.W.G.*

*American Wire Gauge

Secure the extension cord to the unit by tying the cord onto the cord retainer. Insert the cord receptacle in to the recessed plug.

OPERATION

KNOW YOUR ELECTRIC BLOWER

READ THIS OPERATOR'S MANUAL AND SAFETY RULES BEFORE OPERATING YOUR UNIT. Compare the illustrations to your unit to familiarize yourself with the location of the various controls and adjustments. Save this manual for future reference.

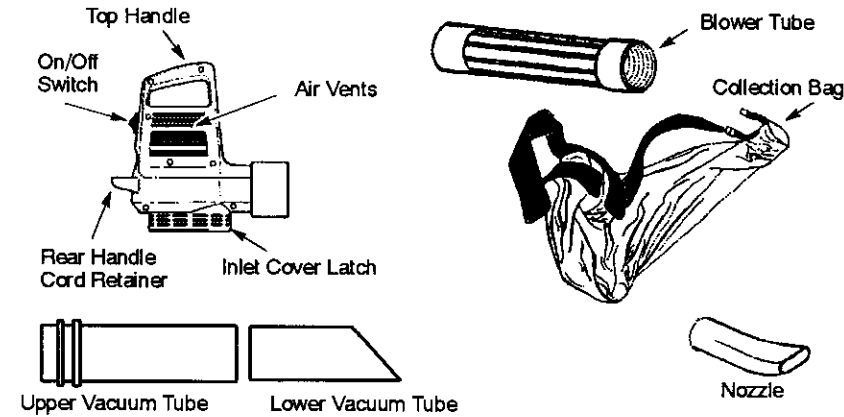

The **ON/OFF SWITCH** is used to activate the motor.

The **INLET COVER LATCH** is used to

open and close the inlet cover.

The **NOZZLE** is designed to direct the flow of air.

OPERATING INSTRUCTIONS

STOPPING YOUR UNIT

Slide the ON/OFF switch to the OFF position.

STARTING YOUR UNIT

Your unit has two run positions, LOW and HIGH. Slide the switch to one of these positions to turn on the unit.

⚠ WARNING: Do not use the unit without the blower tubes, or collection bag properly attached to avoid flying debris and/or impeller contact which can cause serious injury. Always wear eye protection to prevent rocks or debris from being blown or ricocheting into the eyes and face which can result in blindness or serious injury.

USING YOUR UNIT AS A BLOWER

Use your unit as a blower for:

- Sweeping debris or grass clippings from driveways, sidewalks, patios, etc.
- Blowing grass clippings, straw, or leaves into piles, or removing debris

from corners, around joints, or between bricks.

Direct air flow by directing the nozzle down or to one side. Always work away from solid objects such as walks, large stones, vehicles, and fences.

Clean corners by starting in corners and moving outward. This will help prevent an accumulation of debris which could fly into your face.

Be careful when working near plants. The force of the air could damage tender plants.

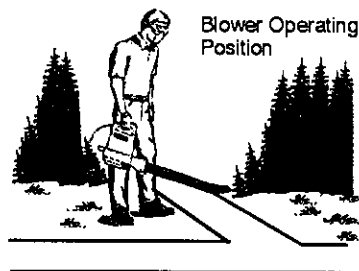

USING YOUR UNIT AS A VACUUM

Use your unit as a vacuum to pick up dry material such as leaves, grass, small twigs, and bits of paper.

- For best results during vacuum use, operate your unit at high speed.
- Move slowly back and forth over the material as you vacuum. Avoid forcing the unit into a pile of debris as this can clog the unit.
- Keep the vacuum tube about an inch above the ground for best results.

NOTE: If the unit becomes clogged, stop the unit and disconnect the extension cord. Wait until the impeller has completely stopped turning, then remove the vacuum tubes. Carefully reach into the vacuum opening and clear out the clogged debris.

CLEANING THE COLLECTION BAG

IMPORTANT: THE COLLECTION BAG MUST BE PROPERLY EMPTIED.

- You must properly empty and maintain the collection bag to avoid deterioration and obstruction of air flow.
- Remove the collection bag from the unit and empty after each use. Do not store bag containing leaves, grass, etc.
- Wash the bag once a year. Remove the bag from the blower and turn the bag inside out. Wash the bag with a water hose. Allow the bag to hang and dry before you reuse the bag.

Vacuum Operating Position



MAINTENANCE

CUSTOMER RESPONSIBILITIES

CARE & MAINTENANCE TASK	WHEN TO PERFORM
Check for Loose fasteners and parts	Before each use
Check for damaged or worn parts	Before each use
Clean unit and labels	After each use
Clean Collection Bag	Yearly

GENERAL RECOMMENDATIONS

The warranty on this unit does not cover items that have been subjected to operator abuse or negligence. To receive full value from the warranty, the operator must maintain unit as instructed in this manual. Various adjustments will need to be made periodically to properly maintain your unit.

BEFORE EACH USE

CHECK FOR LOOSE FASTENERS AND PARTS

- Inlet Cover
- Blower Tube
- Nozzle
- Vacuum Tubes
- Collection Bag

CHECK FOR DAMAGED OR WORN PARTS

Refer replacement of damaged/worn

parts to your Sears Service Center.

- ON/OFF Switch - Ensure switch functions properly by moving the switch to the Off position. Make sure motor stops; then restart motor and continue.

AFTER EACH USE

CLEAN UNIT & LABELS

- Clean the unit using a damp cloth with a mild detergent.
- Wipe off unit with a clean dry cloth.

YEARLY

CLEAN COLLECTION BAG

- Remove the bag and empty after each use. Do not store bag without emptying the bag of all contents.
- Wash the bag once a year by turning inside out and washing with a water hose. Be sure to let bag dry completely before re-using the unit.

SERVICE AND ADJUSTMENTS

HOW TO REMOVE AN OBJECT FROM THE AIR INTAKE

NOTE: If the unit becomes clogged, or an object is drawn into the air intake, stop the unit and disconnect the extension cord. Wait until the impeller has completely stopped turning, then remove the vacuum tubes. Carefully reach into the vacuum opening and clear out the air intake area.

Inspect the impeller for cracks. If cracked or damaged, do not use the

unit. Have parts replaced by your Sears Service Center. Do not attempt to replace them yourself.

PARTS AVAILABLE

Blower Tube	534352705
Vacuum Tube Set	530402499
Inlet Restrictor	530402045
Nozzle	530402461
Collection Bag	530402533
Gutter Kit	71-79997
Safety Glasses	71-85707
Extension Cord	71-5702

STORAGE

Prepare unit for storage at the end of the season or if it will not be used for 30 days or more.

WARNING:

- Secure the unit before storing or transporting.
- Store unit with all guards in place. Position unit so that any sharp object cannot accidentally cause injury.
- Store unit well out of the reach of children.

BLOWER STORAGE

- Disconnect from the power source.
- Clean the entire unit.
- Open inlet cover and clean any dirt.

TROUBLESHOOTING CHART

SYMPTOM	CAUSE	REMEDY
Unit fails to operate.	<ul style="list-style-type: none"> • Switch in the OFF position. • Extension Cord Disconnected • Circuit breaker tripped, or fuse blown • Mechanical failure 	<ul style="list-style-type: none"> • Slide switch to ON position. • Reconnect extension cord. • Reset circuit breaker or fuse. • Contact your Sears Service Center.
Unit vibrates abnormally.	<ul style="list-style-type: none"> • Mechanical failure 	<ul style="list-style-type: none"> • Contact your Sears Service Center
Impeller will not turn freely.	<ul style="list-style-type: none"> • Debris in air intake area. • Mechanical failure 	<ul style="list-style-type: none"> • Clean unit. Remove any debris. • Contact your Sears Service Center