

3M™ Accuspray™ Spray Gun Owner's Manual

Guide d'utilisation des pistolets de pulvérisation Accuspray™ 3M™

Manual de Instrucciones de la Pistola Atomizadora Accuspray™ de 3M™

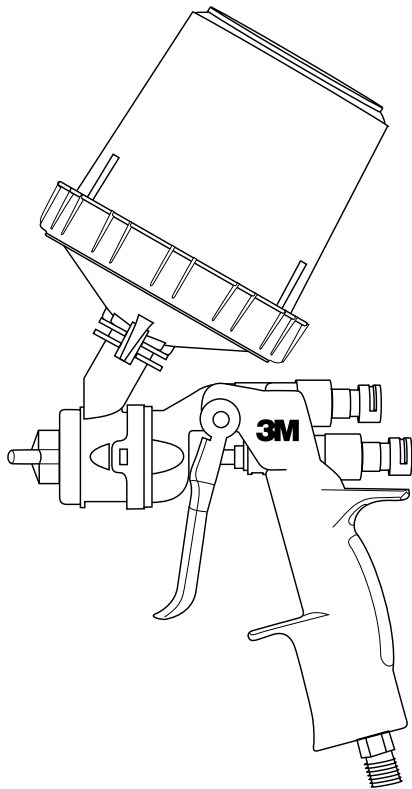

! Read Warnings and Instructions
This Manual Covers 3M™ Accuspray™ Spray Guns
(PN16580, 16579, 16578).

! Lire les mises en garde et les directives.
Ce guide porte sur les pistolets de
pulvérisation Accuspray™ Spray 3M™ (modèles 16580,
16579, et 16578).

! Lea las Advertencias e Instrucciones
Este Manual cubre las Pistolas Atomizadoras
Accuspray™ de 3M™ (PN 16580, PN 16579, PN 16578).



For more information visit our website
3MCollision.com/accuspray-system.

Pour obtenir de plus amples renseignements, veuillez consulter notre site Web à l'adresse 3MCollision.com/accuspray-system.

Para más información, visite nuestro sitio
3MCollision.com/es/accuspray-system.

ORIGINAL INSTRUCTIONS
DIRECTIVES D'ORIGINE
INSTRUCCIONES ORIGINALES

**3M Automotive
Aftermarket Division**

3M Center
St. Paul, MN 55144-1000
651 733 1110



February 13, 2014

Dear Valued 3M Customer,

3M Company, Automotive Aftermarket Division, certifies that the following 3M spray guns meet requirements for classification as High Volume Low Pressure (“HVLP”) spray equipment when operated in accordance with 3M recommended directions for use. 3M AAD defines “HVLP” based on the guidelines outlined in EPA 40 CFR Part 63, Subpart 6H (Jan. 9, 2008):

Accuspray One Spray Gun PN 16579
Accuspray Spray System, HG Series
Accuspray Spray System, HGP Series

Note –Test Air Caps are available for the purposes of demonstrating that 3M spray equipment meets the HVLP definition.

Please contact Monica Bastien, 3M AAD Regulatory Compliance Associate, at 651-733-1849 if there are any additional questions.

Sincerely,

A handwritten signature in black ink, appearing to read 'C. Alonzo Knowles'.

C. Alonzo Knowles
Regulatory Supervisor
3M Automotive Aftermarket Division



EC Declaration of Conformity

Manufacturers Name: **3M**, Automotive Aftermarket Division
Manufacturers Address: 3M Center, Building 223-6N-01
St Paul, MN USA 55144-1000

Does hereby declare under our sole responsibility that the machinery described below complies with those applicable essential health and safety requirements of the Machinery Directive 2006/42/EC; together with all amendments to date.

Description: 3M™ Accuspray™ ONE Spray Gun

Model Number: 16579, or "HGxy", where xy is a 2-digit code referring to the included spray head orifice size

Serial Number Range: Year of manufacture, as marked: "20ab"-to-"2099", where "ab" is any 2-digit number.

The following standards have either been referred to, or complied with, in full or in part as relevant:

EN ISO 12100:2010	Safety of machinery. General principles for design. Risk assessment and risk reduction
EN 1953:2013	Atomizing and spraying equipment for coating materials. Safety requirements
EN 14462:2005+A1:2009	Surface treatment equipment. Noise test code for surface treatment equipment including its ancillary handling equipment. Accuracy grades 2 and 3.

Full Name of responsible person:

Mark N. Schaeffer

Position: Technical Director

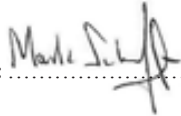
Signature: 

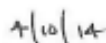
Date: 

St. Paul, Minnesota, USA

Full Name and address of individual responsible to compile technical file within the Community:

Dr. Phil J. Bouie, Country Technical Mgr., Industrial Business Sponsor, 3M United Kingdom PLC,
Ratcliffe Road, Atherstone, Warwickshire, CV9 1PJ, England, United Kingdom, +44-1827-710373

English

3M™ Accuspray™ Spray Gun Safety Statements	4
Intended Use:.....	4
Explanation of Safety Symbols Consequences.....	4
Technical Specifications:.....	5
Spray Gun Overview	6
CONTENTS	6
General Set Up and Spray Gun Use	7
Replacement Parts and Accessories.....	12
Troubleshooting	12
Spray Equipment Warranty and Limited Remedy.....	13

Français

Énoncés relatifs à la sécurité concernant le pistolet de pulvérisation Accuspray™ 3M™.....	16
Usage prévu	16
Explication des symboles sur les étiquettes de sécurité	16
Spécifications techniques	18
Aperçu – Pistolet de pulvérisation.....	19
Préparation et utilisation générale du pistolet de pulvérisation	20
Pièces de rechange et accessoires	25
Dépannage.....	25
Garantie du matériel de pulvérisation et limite de recours.....	26

Español

Declaraciones de Seguridad de la Pistola Atomizadora Accuspray™ de 3M™	29
Intención de Uso:.....	29
Explicación de las consecuencias de los símbolos de seguridad	29
Especificaciones Técnicas:.....	30
Resumen de la Pistola Atomizadora	31
Contenido	31
Desempaque	31
Configuración General y Uso de la Pistola Atomizadora	32
Refacciones y Accesorios.....	37
Búsqueda de Fallas	37
Garantía y Remedio Limitado del Equipo de Atomización.....	38



3M™ Accuspray™ Spray Gun Safety Statements

Read, understand and follow all safety information contained in these instructions prior to set up and operation of any 3M™ Accuspray™ Spray Gun. Retain these instructions for future reference. Refer to the applicable Safety Data Sheet and material container label for each material to be sprayed before using this 3M equipment.

Intended Use:

The 3M™ Accuspray™ Spray Gun and Atomizing Heads are intended for professional use only. They are intended to deliver the desired quality, atomization, and rate of application for larger production needs.

The spray gun must be set up as specified in the 3M™ Accuspray™ Spray Gun Owner's Manual. They are intended for use in a professional/industrial environment only. They have not been evaluated for other uses.

Explanation of Safety Symbols Consequences	
▲ WARNING:	Indicates a hazardous situation, which, if not avoided, could result in death or serious injury.
▲ CAUTION:	Indicates a hazardous situation, which, if not avoided, could result in minor or moderate injury.

▲ WARNING

To reduce the risks associated with all hazards related to the use of this product:

- Read, understand and follow all safety statements in applicable equipment owners' manuals to avoid possible safety hazards.
- This equipment is to be used only by professionals familiar with the possible applicable safety hazards.
- Do not use this product around unsupervised children.
- Never modify any part of this product.
- Always comply with local, state, and national codes governing ventilation, fire protection, operation, maintenance, and housekeeping.

To reduce the risks associated with chemical exposure:

- Never point a spray gun at anyone else or place any part of your body in front of the atomizing head.
- Before use check spray equipment for damage and proper function. Repair/replace worn, damaged or malfunctioning components.
- Always wear appropriate personal protective equipment for eye, skin, respiratory and hearing protection per the applicable MSDS and material container labels at all times when spraying.

To reduce the risks associated with fire and explosion:

- Must maintain adequate ventilation per applicable MSDS and material container labels for each material being sprayed in the work area.
- All ignition sources such as smoking must be kept out of the spray area.
- Always maintain a readily available, approved fire extinguisher or other approved fire fighting equipment in the spray area.

To reduce the risk associated with noise:

- Always wear hearing protection while using the spray gun.

⚠ CAUTION**To reduce the risks associated with tripping, falling and tipping:**

- Route air hoses and any extension cords away from traffic areas, sharp edges, moving parts and hot surfaces. Do not pull on air hoses to move the compressor.

To reduce the risks associated with hazardous air pressure:

- Care for the spray gun per 3M instructions in the applicable owner's manual.
- Ensure air input pressure and all applicator system regulators are properly adjusted per material's recommendations prior to each use.
- Always follow required air pressure relief procedures for relieving air pressure from the spray gun.

⚠ CAUTION**To reduce the risks associated with impact from an atomizing head projectile:**

- Always inspect to ensure that the atomizing head is securely in place and test the spray gun for possible obstruction prior to each use.

To reduce the risks associated with sharp point:

- Do not touch the sharp end of the fluid needle when exposed and handle fluid needles carefully during replacement.

To reduce the risks associated with muscle strain:

- Avoid using spray equipment continuously without taking occasional breaks.

To reduce the risks associated with property damage:

- Do not maintain or service the spray gun other than as instructed in the user's manual.

To reduce the risks associated with environmental contamination:

- Spray materials, solvents, other cleaning materials and electronic components must be disposed of per federal, state and local regulations.

Technical Specifications:

Operator Hand/Arm Vibration level: less than 2.5 m/s²

Declared vibration level in accordance with EN 12096, measurements carried out in accordance with standard EN ISO 28662-1 and EN ISO 20643.

Declared Dual-Number Noise Emission Values according to EN ISO 4871

A-WEIGHTED EMISSION SOUND PRESSURE LEVEL AT THE WORKSTATION:

Measured value: $L_{pA} = 71,4$ dB(A) (ref 20 μ Pa)

Uncertainty: $K_{pA} = 2,5$ dB

A-WEIGHTED SOUND POWER LEVEL:

Measured value: $L_{WA} = 83,1$ dB(A) (ref 1 pW)

Uncertainty: $K_{WA} = 2,5$ dB

Values determined according to noise test code EN 14462 using the basic standards

EN ISO 11201 - grade 2, and EN ISO 3741

NOTE: The sum of a measured noise emission value and its associated uncertainty represents an upper bound of the range of values which can occur in the measurements.

IMPORTANT NOTE: The noise and vibration values stated are from laboratory testing in conformity with stated codes and standards and are not sufficient risk evaluation for all exposure scenarios. Values measured in a particular work place may be higher than the declared values. The actual exposure values and amount of risk or harm experienced to an individual is unique to each situation and depends upon the surrounding environment, the way in which the individual works, the particular material being worked, work station design, as well as upon the exposure time and the physical condition of the user. 3M cannot be held responsible for the consequences of using declared values instead of actual exposure values for any individual risk assessment.

3M

Spray Gun Overview

3M™ Accuspray™ Spray Guns were designed from the inside out for the effective, efficient, and economical application of paints, adhesives, coatings and finishes. This spray gun has a large spray pattern with very low overspray. The soft, tight, adjustable pattern with complete atomization results in a high finish quality and absolute control. Each ultra-light weight spray gun is designed for easy handling, reliability and durability and for minimum maintenance costs. Combine your 3M™ Accuspray™ Spray Gun with the 3M™ PPS™ Paint Preparation System and enjoy additional savings of time and cleaning solvents.

3M™ Accuspray™ Spray Gun is for professional use only. Hazards can occur from equipment misuse. Any misuse of the equipment or accessories, such as over pressurizing, modifying parts, using incompatible chemicals and fluids, or using worn or damaged parts can cause serious bodily injury, fire, explosion or property damage. **Read and follow all Safety Statements and Instructions.**

CONTENTS

Unpacking

Remove the components from the box. Inspect for concealed damage and/or missing items. If you discover any damage and/or missing pieces, contact your distributor immediately.

Your 3M™ Accuspray™ Spray Gun Kit could include one or more of the following, depending on the kit that was purchased:

- 1 Spray Gun Body
- 1 Air Flow Control Valve
- 1.2 mm atomizing head
- 1.3 mm atomizing head
- 1.4 mm atomizing head
- 1.8 mm atomizing head
- 2.0 mm atomizing head
- 10 Color Identification Clips (2 each of 5 colors)
- PPS™ Standard Size Mixing Cup and Collar
- PPS™ Standard Size Lids and Liners
- PPS™ Sealing Plugs
- PPS™ Generic Mix Ratio Insert
- Spray Gun Hanger

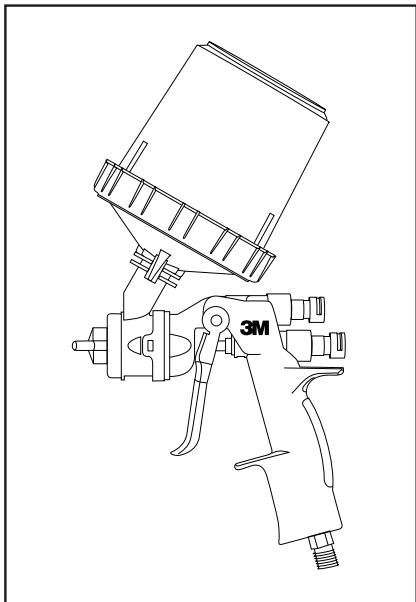

3M™ Accuspray™ Spray Gun

The 3M™ Accuspray™ Spray Gun features a black composite* body, 13 scfm (370.5 L/min) air consumption, 1/4" (1/4" BSP) air inlet and 20 psi (1.4 bar) maximum inlet pressure with full trigger pull **. This spray gun is for use with compressed air systems.

* Product material compatibility information available upon request.

** Maximum inlet pressure at a 2:1 reduction ratio will yield approximately 10 psi (0.69 bar) at the air cap.

General Set Up and Spray Gun Use

Note: Complete steps below before connecting spray gun to air source.

One atomizing head may already be semi-attached to the spray gun body in the package. You only need to fully engage and secure onto the spray gun body. Follow the procedure below.

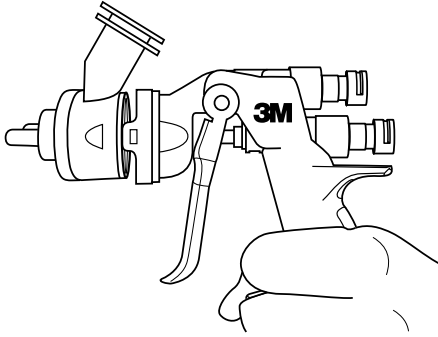

Attaching the Atomizing Head

1. Pull trigger back and hold.

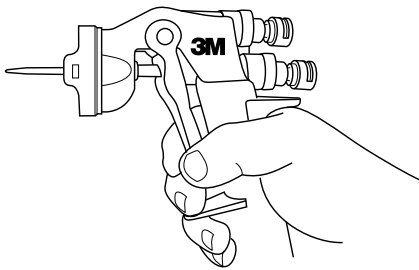

2. Slide the atomizing head over the fluid needle and push towards the spray gun body making sure the release buttons are aligned with the latch openings.

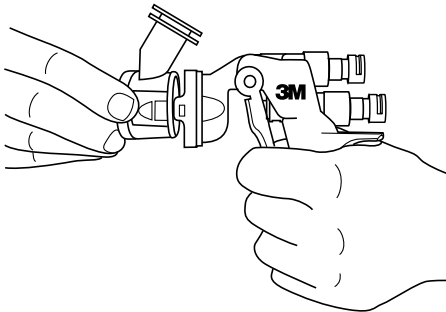

3. Secure the atomizing head and listen for the “clicking” sound for full engagement then release the trigger.

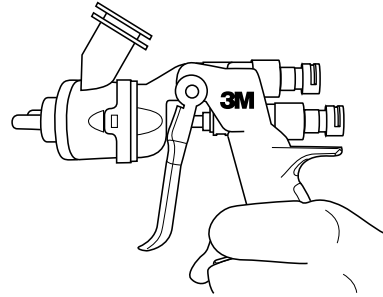

Note: It is not necessary to pull the trigger back when changing the atomizing head. To change the atomizing head simply depress release buttons and pull the atomizing head away from the spray gun body. Make sure fluid needle is clean when replacing the atomizing head. Then follow “Attaching the Atomizing Head” procedure for connecting atomizing head.

Attaching Air Fitting or Regulating Equipment

It will be necessary to connect an air fitting, an air regulator or air flow control valve to the air inlet located at the base of the spray gun body.

Note: Do not use the spray gun body to tighten the connection with air flow control valve.

Note: When used with flammable materials this device must be grounded. A test for adequate grounding should be performed regularly.

General Set Up and Spray Gun Use cont.

Spray Gun Identification

Attach color clips into the groove on the fan and fluid adjustment knobs, to identify the application of the spray gun use.

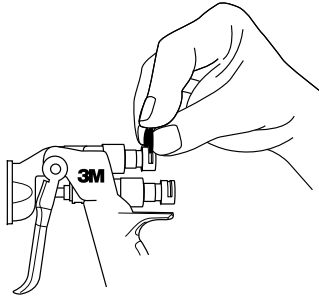

Example of attaching air flow control valve:

1. Manually attach the air flow control valve to the air inlet by hand threading the connection.

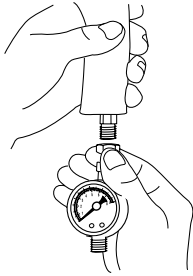

2. Use two wrenches to connect the air flow control valve. Adjust to fit the air inlet and adjust the other to fit the air flow control valve then tighten the connection.

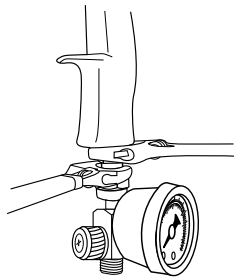

Setting the Air Pressure

Pull trigger back (fluid and air/full trigger pull) and adjust operating pressure to read 20 psi (1.4 bar) for optimum spray performance.

Adding the PPS™ Components

3. To facilitate measurement of materials to be sprayed according to manufacturer's guidelines, place the 3M™ PPS™ Mix Ratio Film Insert into the 3M™ PPS™ mixing cup.

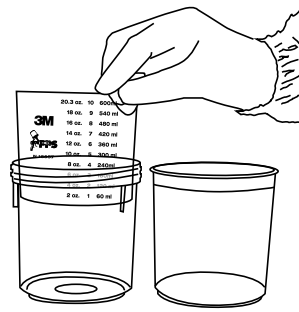

4. Insert the 3M™ PPS™ liner into the 3M™ PPS™ mixing cup.

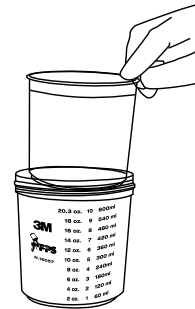

5. Pour material to be sprayed into the 3M™ PPS™ mixing cup. Stir as needed.



6. Place the 3M™ PPS™ lid with built-in filter on top of the 3M™ PPS™ mixing cup with liner and snap into place.



- 7. Position the 3M™ PPS™ collar onto the 3M™ PPS™ mixing cup with liner and turn until tight. Insert 3M™ PPS™ sealing plug prior to shaking or storage.

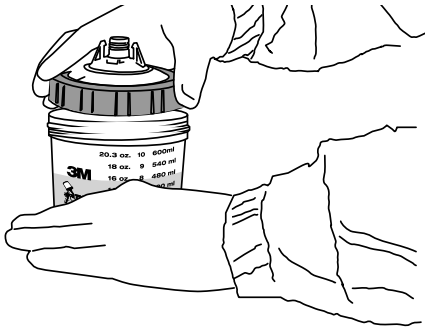

- 8. Attach spray gun to filled 3M™ PPS™ cup.



Adjusting the Fluid Flow

The fluid flow can be adjusted by using the fluid needle adjustment knob as noted in Fig. 1. The spray gun in the kit is preset in the **closed** position (pull trigger to verify; there should be minimal fluid needle movement). To allow fluid flow, gently turn the fluid needle adjustment knob counter-clockwise 3 full turns. These adjustment procedures will serve only as a starting point. Fine tuning of these adjustments will be based on your material and technique.

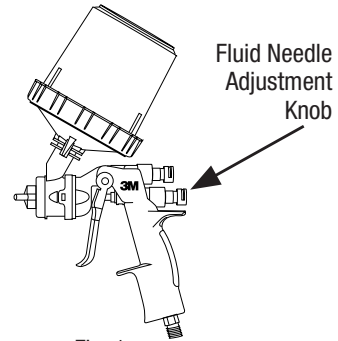
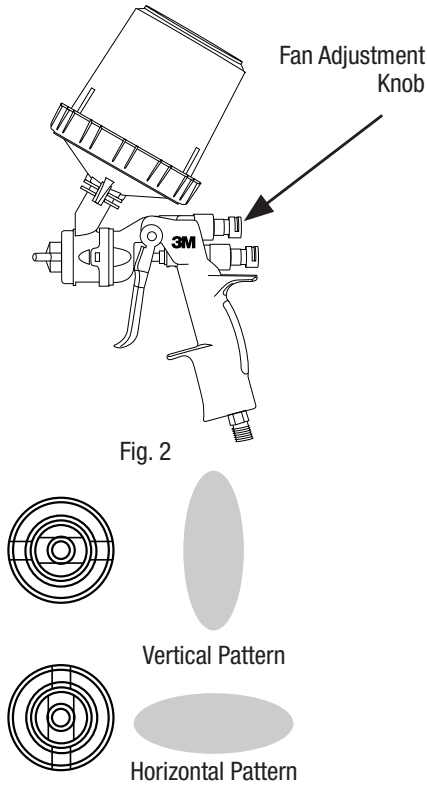

Fig. 1

General Set Up and Spray Gun Use cont.

Adjusting the Fan Pattern Size

The fan size is regulated by the fan adjustment knob as noted in Fig. 2. The spray gun in the kit is preset in the closed position (gently turn the fan adjustment knob clockwise to verify; knob should not move). Next, turn the knob counter-clockwise full rotation. The fan adjustment will allow you to spray from a small round to a full fan pattern.



Note: The spray pattern can also be changed from vertical to horizontal by rotating the air cap a 1/4 turn.

Note: Do Not Put In Gun Washer. Read, understand and follow all safety statements as well as wear appropriate, approved personal protective equipment per the applicable SDS and material container labels for cleaning solutions.

Periodically, lubricate moving components such as the fluid needle, fan adjustment threads, fluid needle adjustment threads and spring.

Do not point the spray gun up while cleaning it.



Do not immerse the spray gun in solvent.



Do not wipe the spray gun with a cloth soaked in solvent; wring out the excess.

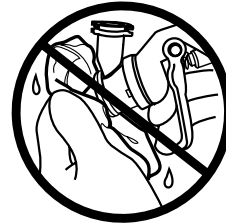

Do not use metal tools to clean the air cap holes as this may scratch them; scratches can distort the spray pattern.

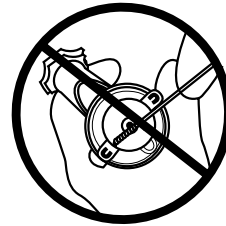

⚠ ATTENTION**Note: Do Not Put In Gun Washer.**

Solvent left in the spray gun air passages could result in a poor quality paint finish. Do not use any cleaning method which may allow solvent into the spray gun air passages. Do not expose air flow control valve and gauges to solvent as damage may occur.

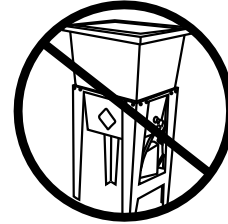
**Cleaning Process**

1. Relieve the air and fluid pressure from the spray gun and cup before servicing.
2. To retain unused paint or temporarily store mixed material, see your Local, State, Federal and OSHA guidelines, along with paint manufacturer's recommendations for storage.
3. To flush spray gun, run water or compatible and compliant solvent into the spray gun fluid passage while triggering the spray gun until the cleaning fluid appears clear.

Note: If feasible, clean atomizing head prior to disposal. Dispose of all used atomizing heads and spray gun bodies in accordance with federal, state and local regulations. To change the atomizing head, refer to the section "Attaching the Atomizing Head" on page 7.

Replacement Parts and Accessories

Description

Replacement PN

3M™ Accuspray™ Fluid Needle	16571
3M™ Accuspray™ HVLP Test Air Cap	16572
3M™ Accuspray™ Air Flow Control Valve	16573
3M™ Accuspray™ ONE Replacement Spray Gun Kit	16579
3M™ Accuspray™ Atomizing Head Refill Kit 2.0 mm	16609
3M™ Accuspray™ Atomizing Head Refill Kit, 1.8 mm	16611
3M™ Accuspray™ Atomizing Head Refill Kit, 1.4 mm	16612
3M™ Accuspray™ Atomizing Head Refill Kit 1.3 mm	16614
3M™ Accuspray™ Atomizing Head Refill Kit 1.2 mm	16615
3M™ Accuspray™ Magnetic Spray Gun hanger	16236

Troubleshooting

<i>Problem</i>	<i>Cause</i>	<i>Remedy</i>
Gun leaking fluid behind trigger	Atomizing head seals	Replace atomizing head and clean needle
Trigger sticking	Dirty needle	Clean needle
Leaking air around Atomizing head seal	Atomizing head not secured in latches	Remove atomizing head and reattach in gun body and listen for double click
Atomizing head won't stay on gun	Frayed latch tabs on atomizing head	Replace atomizing head
Gun leaking fluid in gun holder	Wrong gun holder or support	Use 3M gun hanger PN 16236
Gun body leaking air behind trigger	Bad Poppet seal	Replace gun: Call 1-877-MMM-CARS or (1-877-666-2277)
Can't hear double click when attaching atomizing head	Frayed latch tabs on atomizing head	Replace atomizing head
New atomizing head leaking fluid	Scored seals in atomizing head	Clean needle and replace atomizing head

Spray Equipment Warranty and Limited Remedy

3M warrants to the original purchaser that, when used in accordance with 3M's written instructions, 3M spray equipment will be free of defects in materials and manufacture for year from the date of purchase. This warranty does not apply to damage or malfunction caused by normal wear, failure to maintain, or by any abuse, accident, tampering, alteration, or misuse of the spray equipment.

To make a claim under the warranty, you must first contact the 3M Service Center at 1-877-MMM-CARS to receive a return authorization number. Spray equipment must be returned, freight prepaid by the purchaser, to the service location address given by the 3M Service Center. Upon validation of the warranty claim, 3M will replace or repair the spray equipment, at 3M's option, and return it to the purchaser at 3M's expense, including parts, labor and return shipping charges. If it is determined that the claim is not covered by the warranty, the purchaser will be given the option to have the spray equipment repaired outside of the warranty. An estimate of parts and labor will be provided by 3M and must be approved by the purchaser in advance.

Except as written above, 3M MAKES NO OTHER WARRANTIES OR CONDITIONS, EXPRESS OR IMPLIED, INCLUDING, BUT NOT LIMITED TO, ANY IMPLIED WARRANTY OR CONDITION OF MERCHANTABILITY OR FITNESS FOR A PARTICULAR PURPOSE OR ANY IMPLIED WARRANTY OR CONDITION ARISING OUT OF A COURSE OF DEALING, CUSTOM OR USAGE OF TRADE. Many factors beyond 3M's control and uniquely within user's knowledge and control can affect the use and performance of a 3M product in a particular application. Given the variety of factors that can affect the use and performance of a 3M product, user is solely responsible for evaluating the 3M product and determining whether it is fit for a particular purpose and suitable for user's method of application.

Limitation of Liability: Except where prohibited by law, 3M will not be liable for any loss or damage arising from the 3M product, whether direct, indirect, special, incidental or consequential, regardless of the legal theory asserted, including warranty, contract, negligence or strict liability.

TO PLACE AN ORDER, contact your 3M AAD Sales Representative or Distributor, or call the number below:

3M Automotive Aftermarket Division

3M Center, Bldg. 223-6N-01
St. Paul, MN 55144-1000
1-877-MMM-CARS (666-2277)

3MCollision.com

All written and visual data contained in this document reflects the latest product information available at the time of publication.

3M reserves the right to make changes at any time without notice.

PRINTED IN U.S.A. © 3M 2015. All rights reserved.

3M, Accuspray and PPS are trademarks of 3M Company, used under license in Canada.

