

Service Manual



VideoCAM NB300

Table of Contents

1. Introduction.....	3
A. Features	3
B. System Requirements.....	3
C. Function Block.....	3
2. Removal and Replacement.....	4
3. Troubleshooting Guide.....	5
4. Testing Procedures	6
5. Parts List	14
6. Tools.....	14

1. Introduction

A. Features

- Up to 1280X960 pixel in digital camera mode
- Built-in snapshot button
- USB 1.1 interface

B. System Requirements

- Pentium 200MHZ MMX CPU or higher and at least 128MB RAM
- 5MB available hard disk space
- Video card with 2MB of RAM for minimum
- 4X CD-ROM Drive
- Available one USB port

C. Function Block

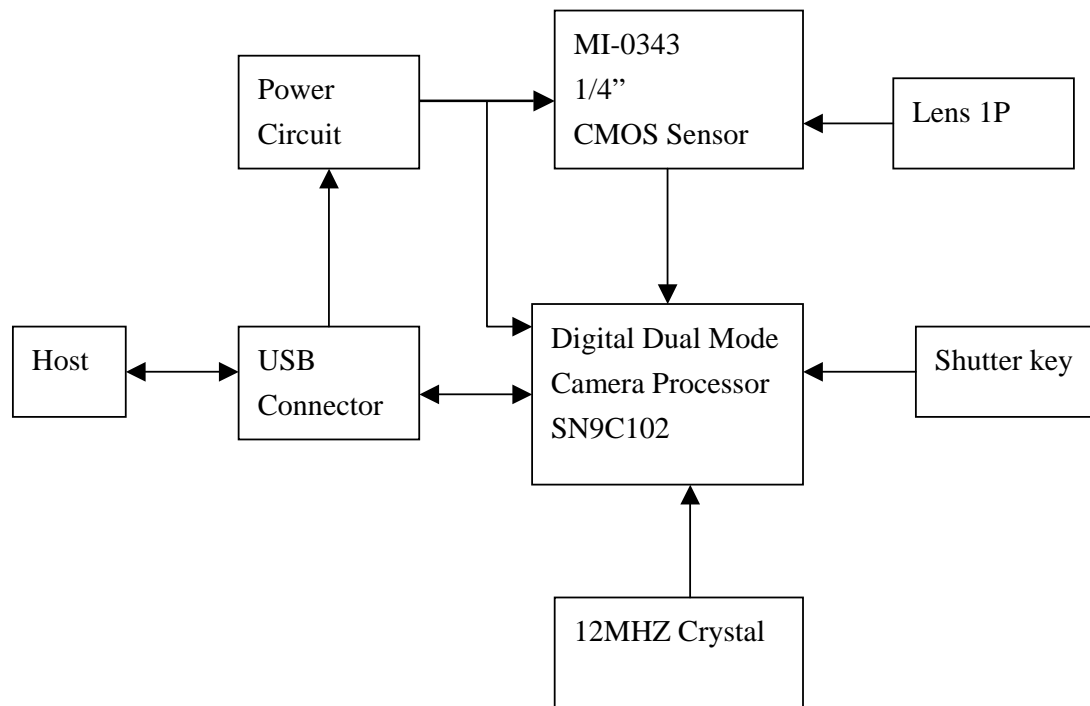

2. Removal and Replacement

AS SAME AS THE VideoCam NB.

3. Troubleshooting Guide

Problem	Solution
No Power	U4 NG , Cable NG
Image is Blur	Check the Lens
Can not connect to PC	U2, Y1 NG
Can Not Capture Image	U2, U3 NG

4. Testing Procedures

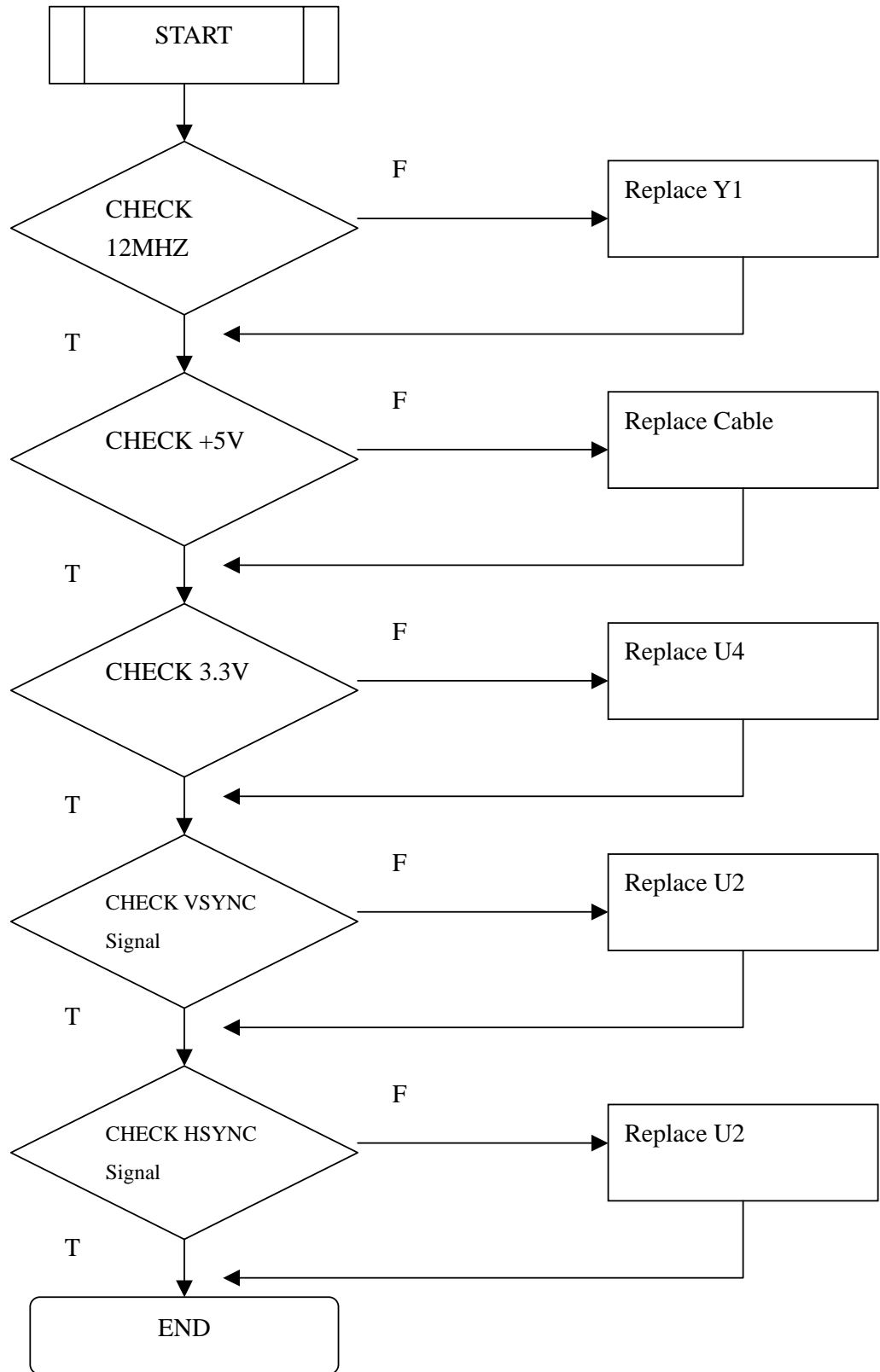

● CHECK Y1 12MHZ

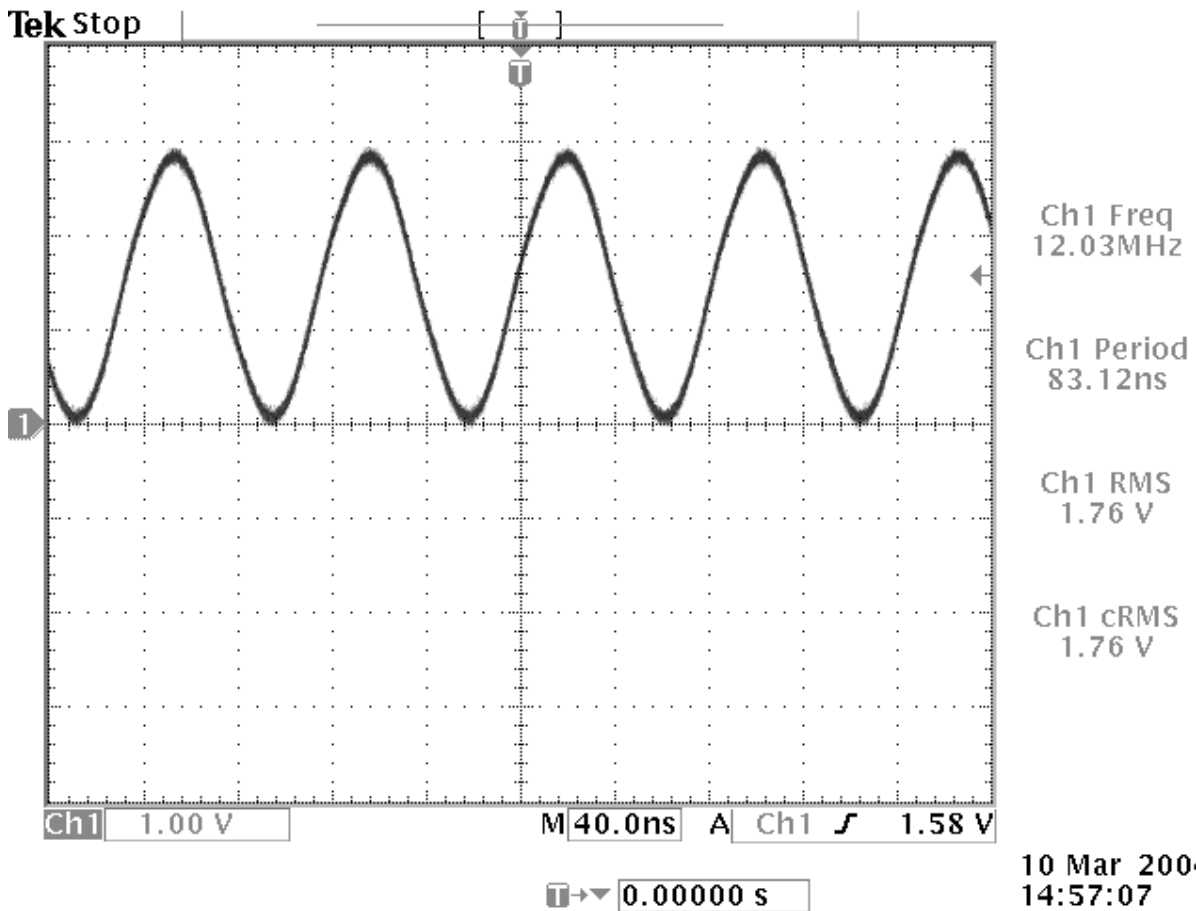

● CHECK U4 Pin 2 +5V

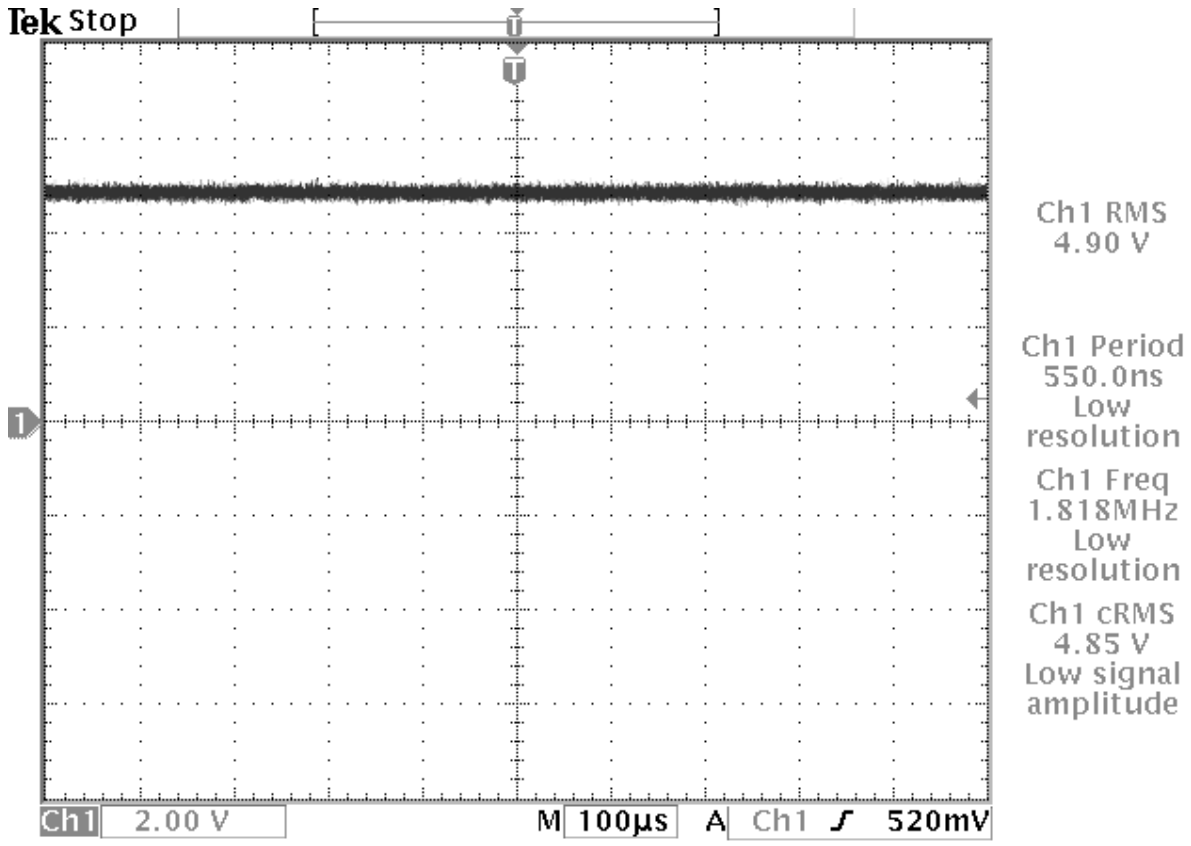

19 Feb 2004
10:24:30

● CHECK U4 Pin 3 +3.3V

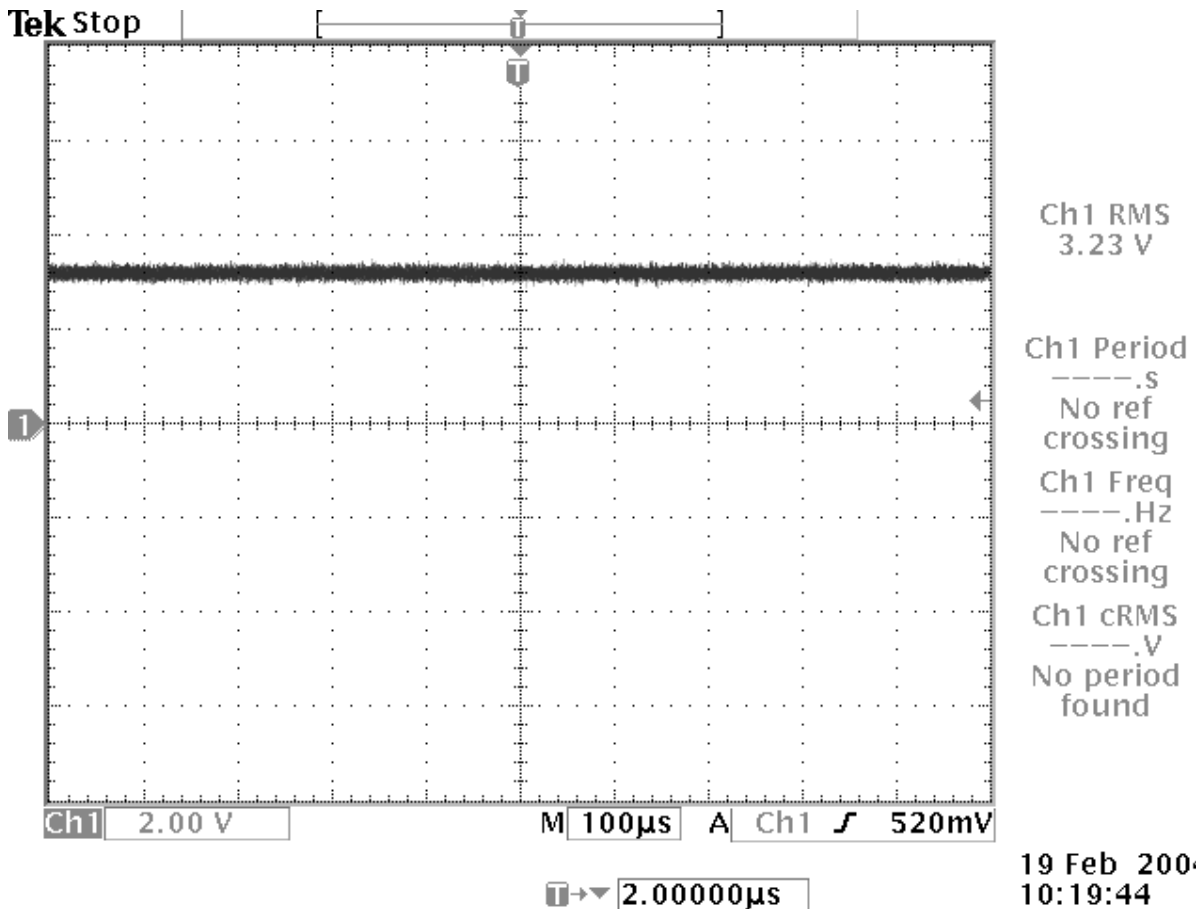

● CHECK VSYNC Signal

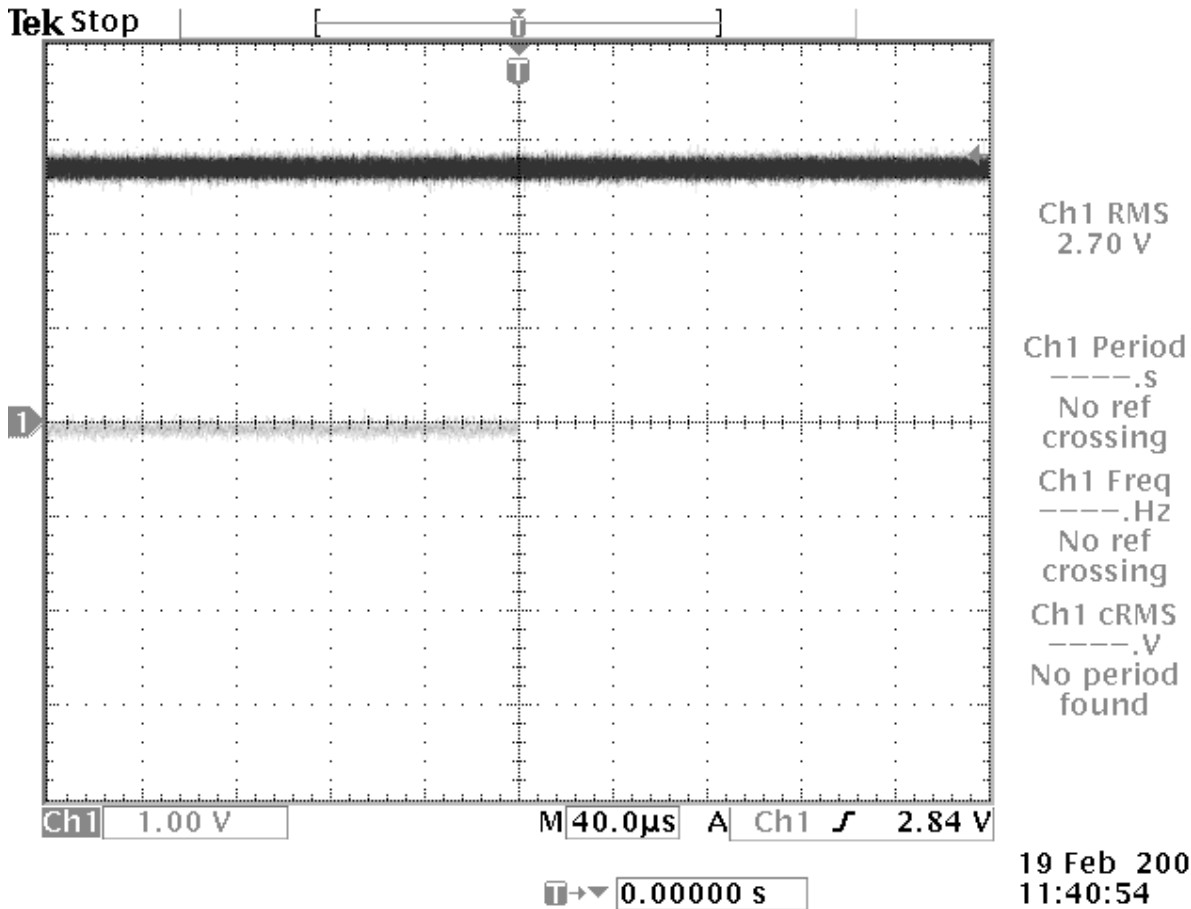
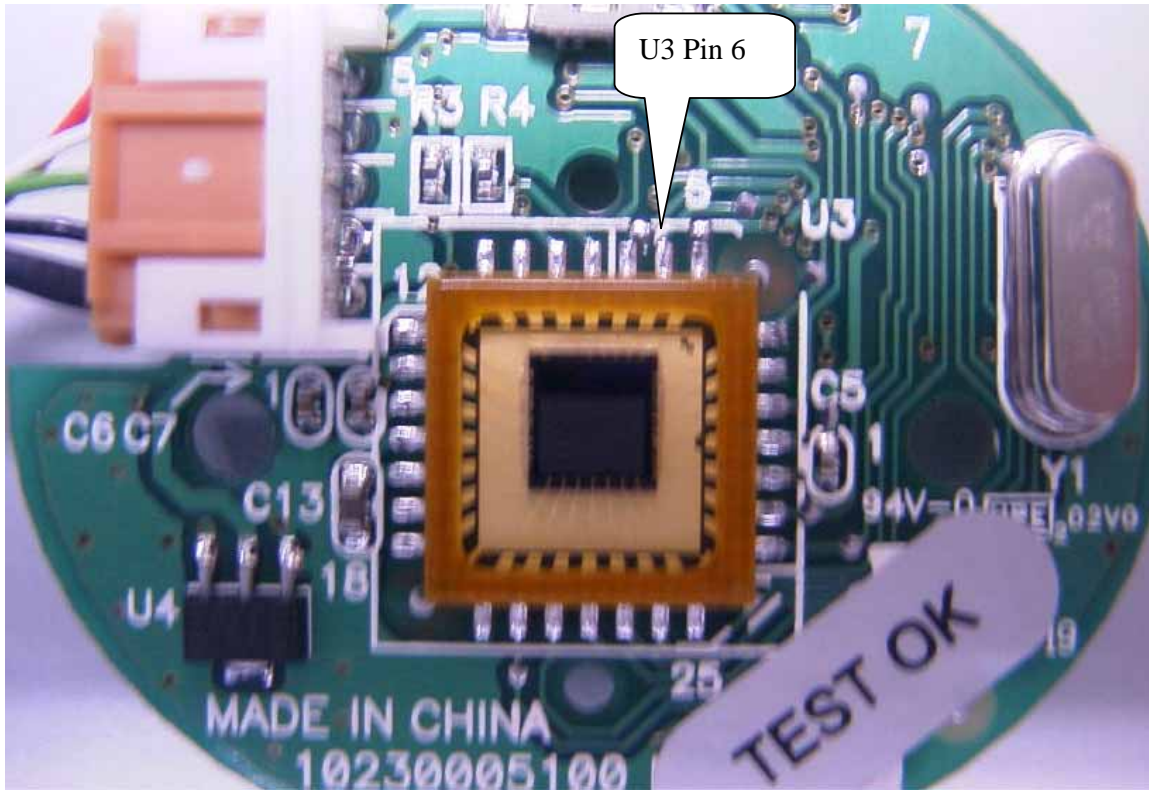

● CHECK HSYNC Signal

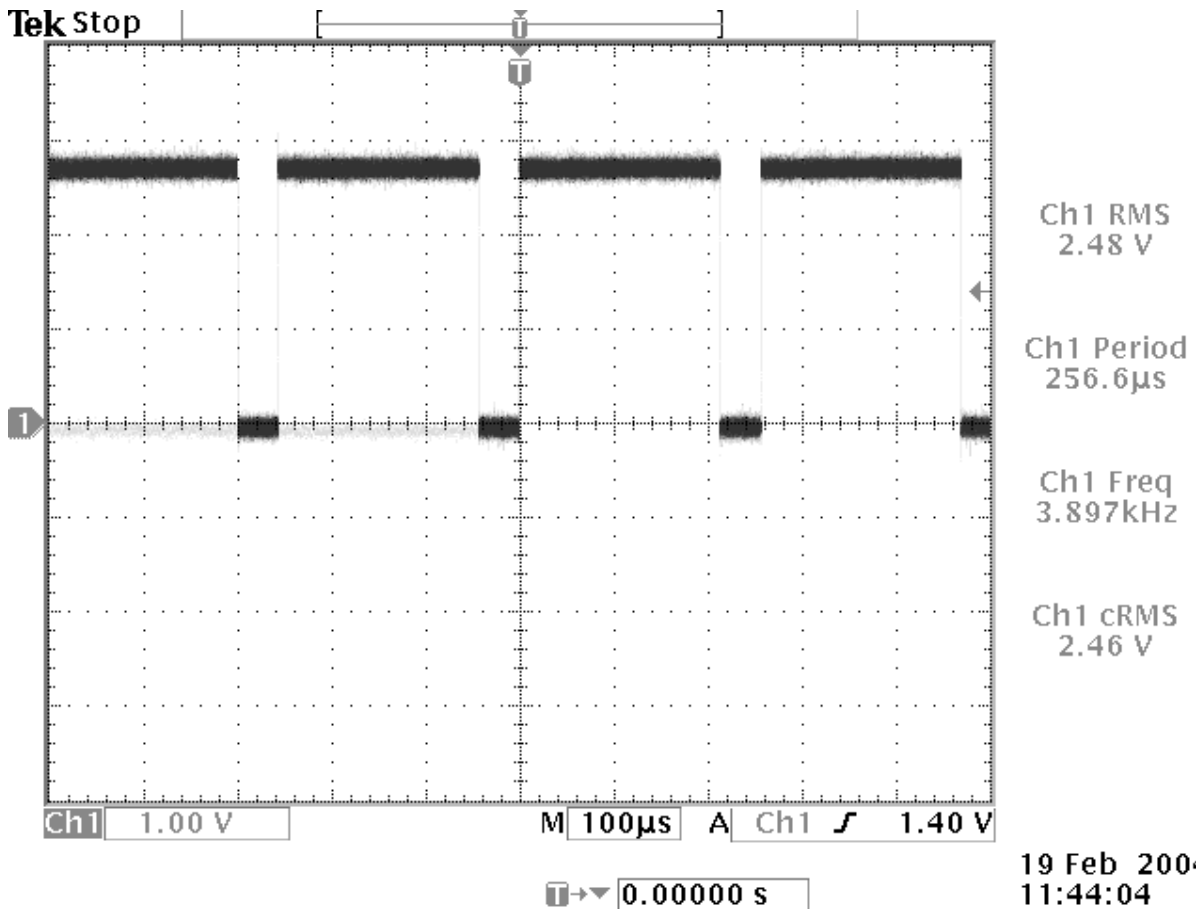
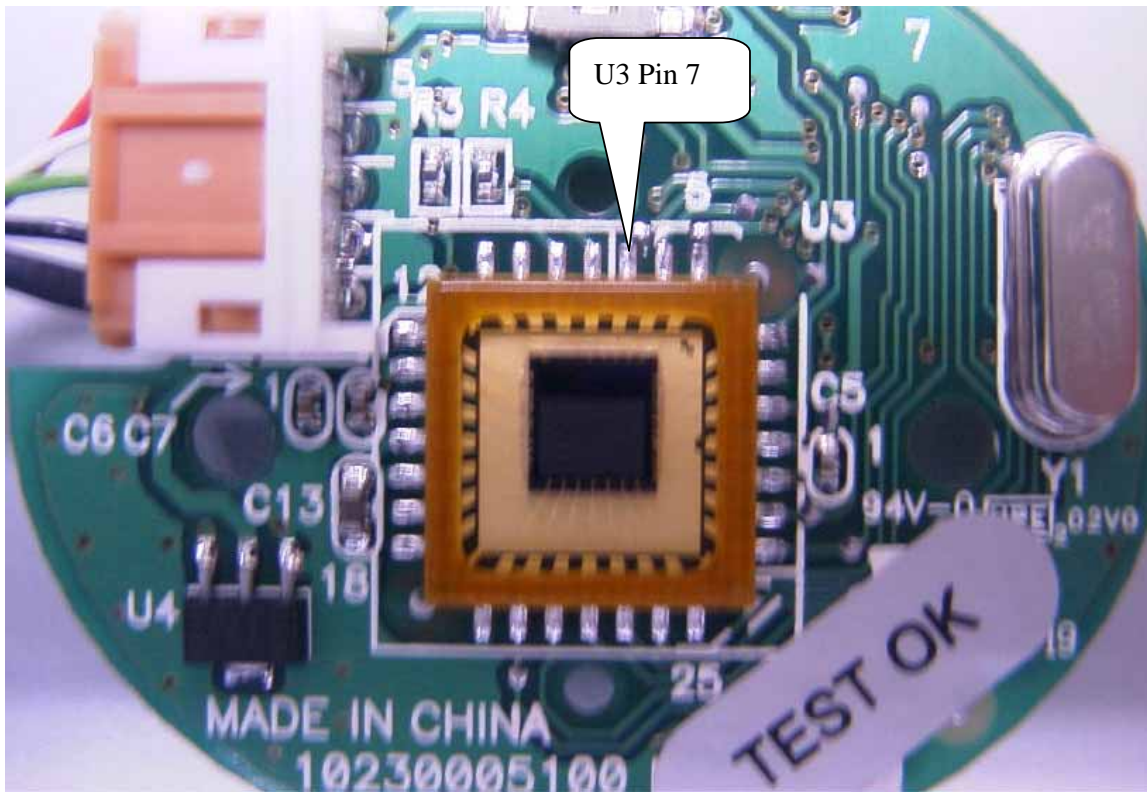

19 Feb 2004
11:44:04

● DN Signal

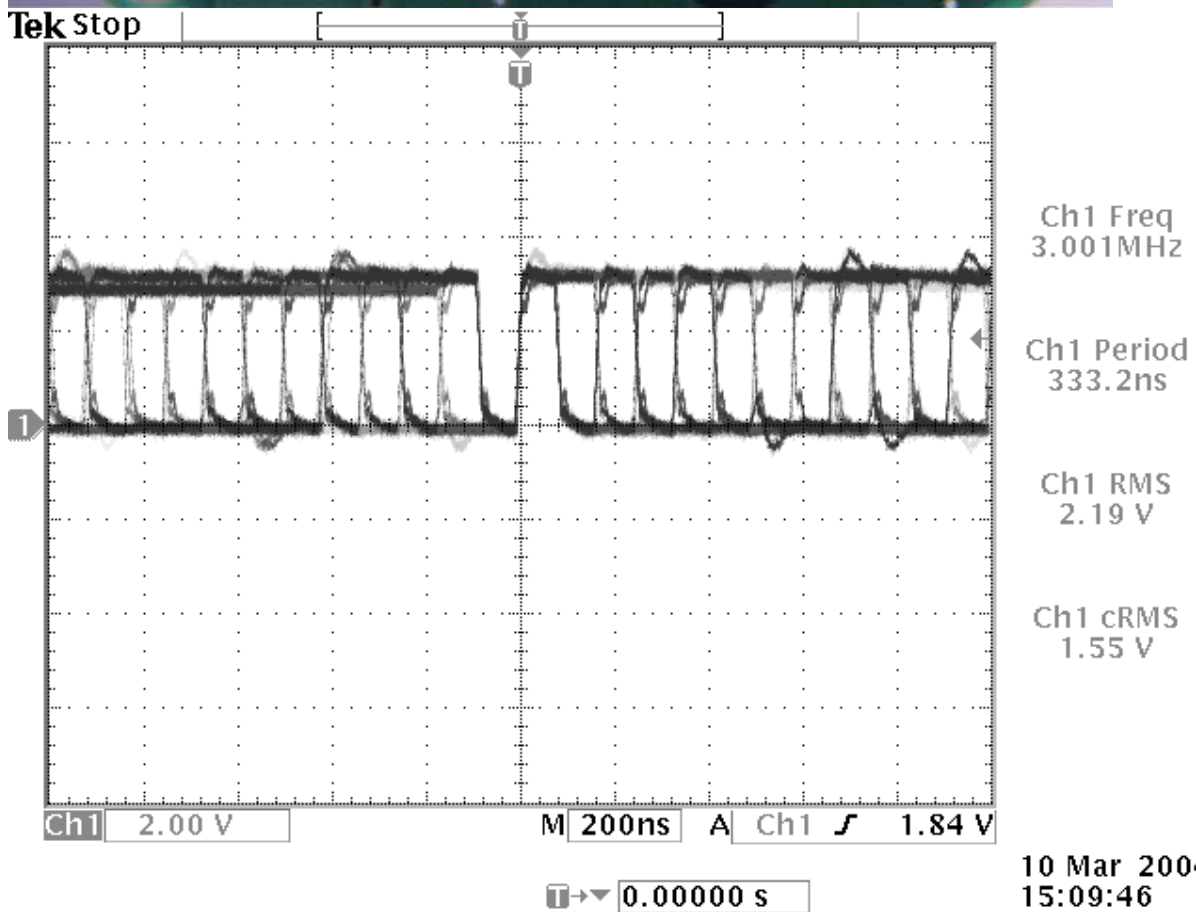
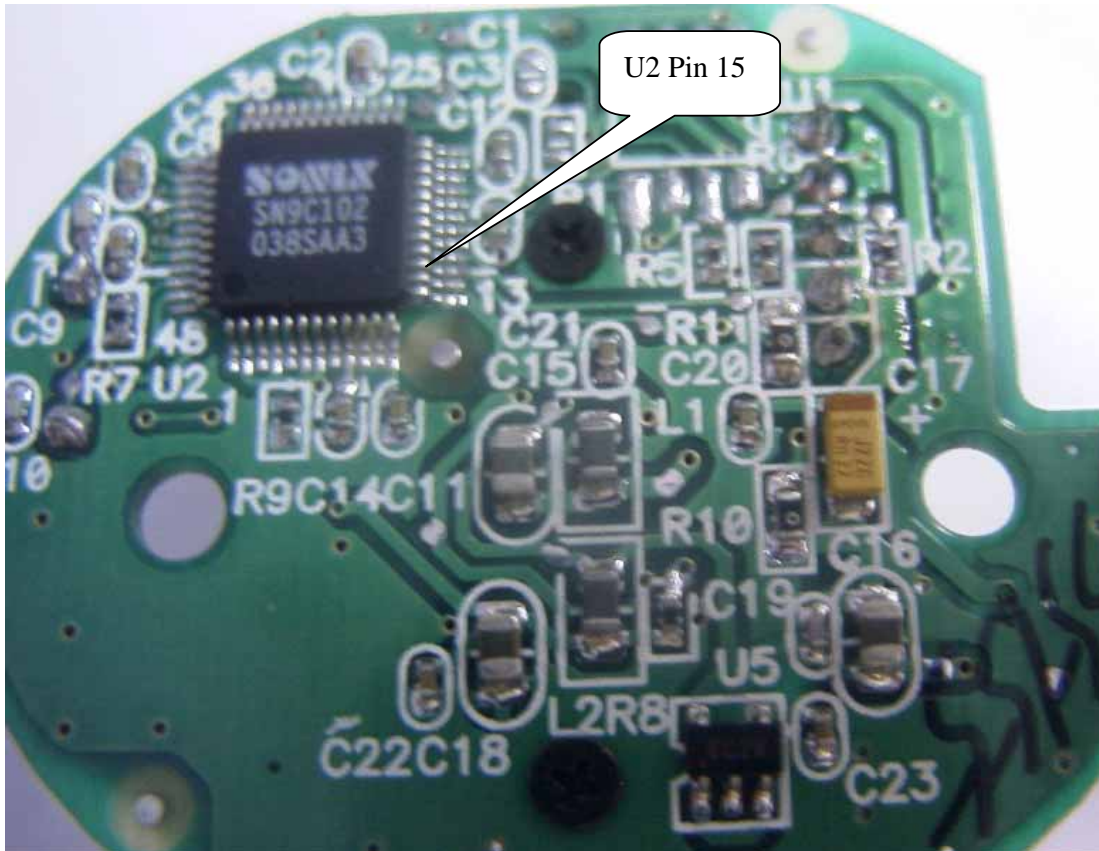

● DP Signal

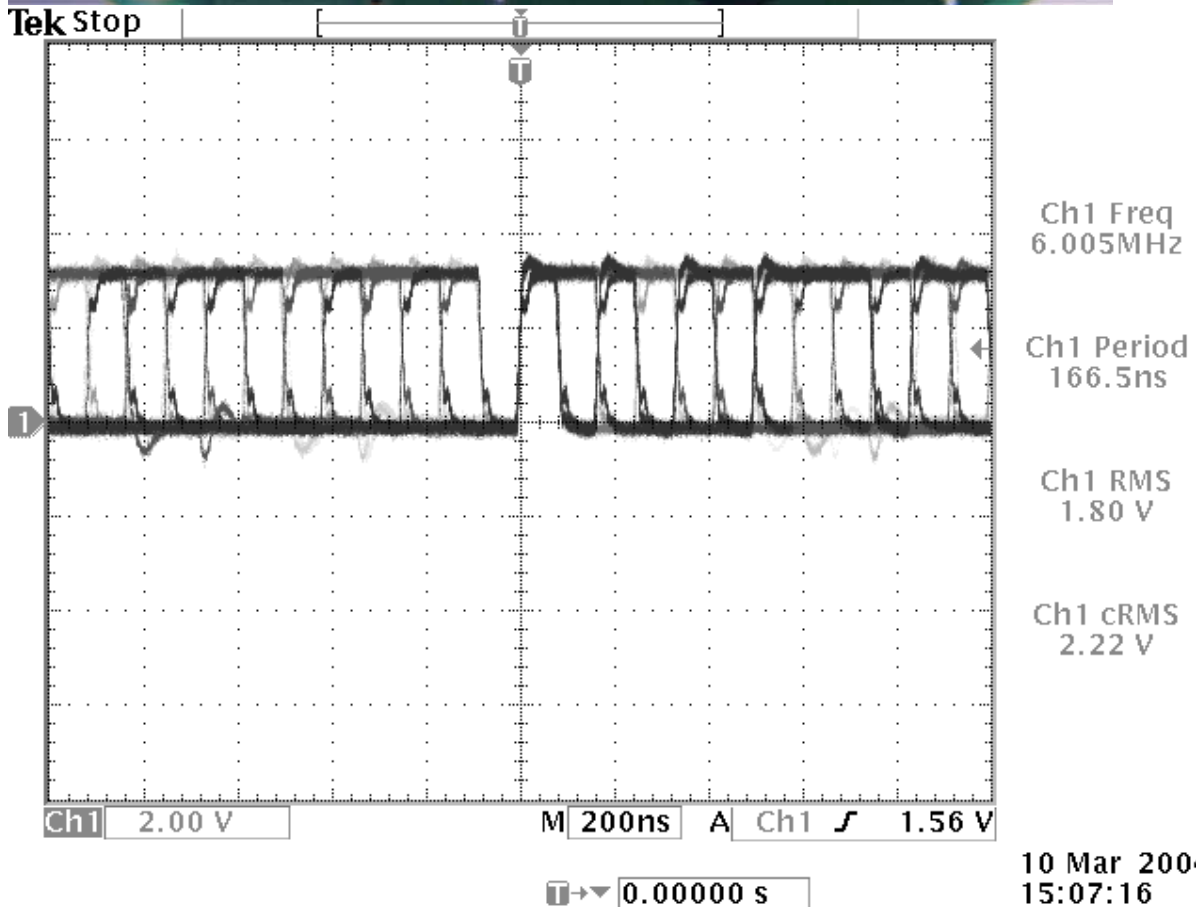
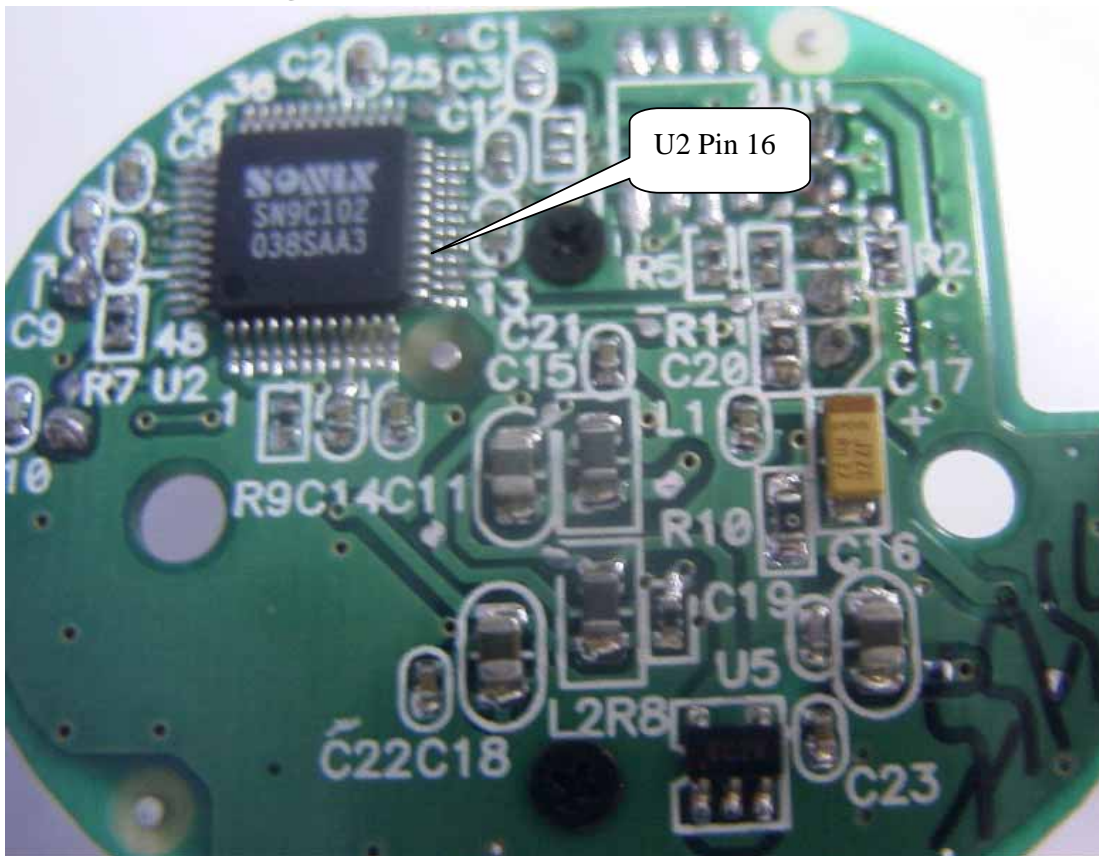

5. Parts List

Item	Part number	Description	Position
1	10800053000	Crystal 12MHZ	Y1
2	15160621000	Cable	
3	11310009000	Chip regulator	U4
4	11300491000	IC SN9C102	U2
5	11300497000	IC MI-0343	U3

6. Tools

- **Screwdriver Cross**
- **Oscilloscope**